

ispark annexe

(inside, physics, examples & more)

CONTENT

- Annex A: An extreme mixed circuit with cables**
- Annex B: Instant arc suppression**
- Annex C: Low voltage battery circuits**
- Annex D: Spark's energy balance**
- Annex E: Electronic current limiters**
- Annex F: *ispark* with more complex situations**
- Annex G: Systematics of minimum ignition data**
- Annex H: Statistics of ignition processes**
- Annex I: Aggravated ambient conditions**
- Annex J: Imperfections of components (under construction)**
- Annex K: Very high voltages**
- Annex L: A statistical approach to spark ignition**
- Annex M: Checking presented ignition Data**

Annex A: An extreme mixed circuit with cables

Up to now, many people and experts too, are confused about possible interactions between capacitances and inductances combined in one and the same intrinsically safe circuit. This chapter is intended to clarify this complication in a physically oriented view.

As a result, it should become clear, how this interaction works and in which manner cables are affected also.

Capacitance's ignition capabilities

Reference ignition data of IEC 60079-11 concerning capacitances are reported in figure A.3 as shown at the right.

Attention here shall be drawn to the added red line marking a voltage of 10 V. Obviously IEC 60079-11 reports ignitions for lower voltages too.

At a first glance this seems not to be remarkable. At the second one should be aware of the fact, that below 10 V no sparks can exist; at such low voltages a contact will, up to high currents, proper switch without sparking.

Therefore it must be some means within the tested circuit, able to rise the voltage significantly, which is not encountered nor reported.

One look into IEC 60079-11, B.1.2, concerning the standardized spark test apparatus' properties points out a maximum value for its internal inductance of up to 3 μH . May this inductance, although very small, be responsible for the contradiction?

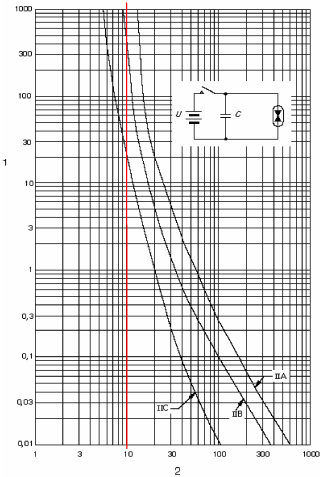

An example

The description of this spark phenomenon shall be illustrated by some quantitative data using *ispark's* spark type s/o-1.

For a given voltage of 7.5 V, for example, fig. A.3, IEC 60079-11, allows a capacitance of about 100 μF for the gasgroup IIC. Taking into account a spark test apparatus' inductance of 1 μH and a resistance of 0.2 Ω , this circuit reveals a peak current of about 27 A (R_q is as high, not to have a significant effect).

Considering the spurs acc. to *ispark* procedures:

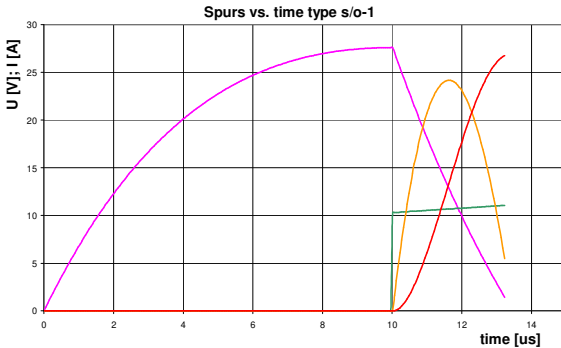

$$C_x = 100 \mu\text{F}; L_x = 0.001 \text{ mH}$$

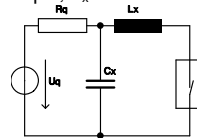

Note: scale is adjusted here to:
 voltage [V] green
 current [A] magenta
 power [$1/5 \cdot W$] orange
 temperature [$1/20 \cdot ^\circ\text{C}$] red

Such high current, short endurance sparks are not reported of in IEC 60079-11. The highest values mentioned there are several Amperes but for comparison, two values shall picked out here:

- Figure A.1 doesn't show an ignition risk at all with resistive circuits up to 5 A.
Note: Spark test apparatus' internal inductance naturally must be included here.
- Figure A.6 reports a current of about 2.5 A for an inductance of 10 μH .
Note: Conversion to 1 μH on the base of energetic conclusions will return a value of about 8 A.

High currents of several ten amperes at low voltages were experimentally investigated for example when testing batteries in direct short circuit. Data comply with the order of 27 A and 1 μH mentioned above.

As a result, one can state, that the ignition properties reported in IEC 60079-11 for "capacitive" circuits are not in contradiction to spark physics at all, but an unrecognized parameter plays a surprising role if voltages are low. *ispark* offers the possibility to calculate the situation for arbitrary inductances. For 5 μH and 20 μH instead of 1 μH , the results are shown on the right:

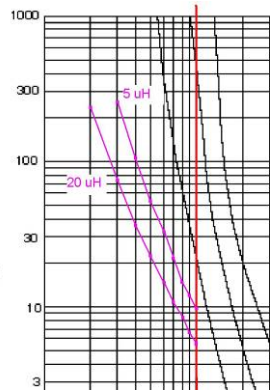

Obviously, already small inductances (which may arise with short cable lengths) reveal a dramatic effect with the 'capacitive' ignition curve.

Fortunately, inductances are always accompanied by a resistance resulting in an efficient decrease of the peak current and thus moderating the situation. This is especially with cables. But see the following chapter.

What's the difference with cables?

The most important feature with cables is a strict ratio of capacitive, inductive and resistive appearances.

A typical cable has, for example, a distributed inductance of 0.7 mH/km and a resistance of 25 Ω/km ; the according lengths for 5 μH resp. 20 μH are about 7/28 m, resistances 0.19/0.74 Ω , propagation delay 0.11/0.44 μs . Inclusion of the resistances has the results shown at the right:

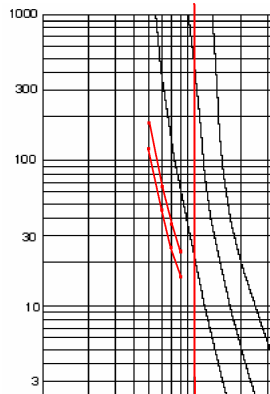

Note: all other cable related effects like time delays are negligible, because the interesting cable lengths are very short (20 μH may fit to about 30 m). As cable capacitance here is very small compared to the lumped capacitance, the circuit diagram shown above will also be suitable with the deviation, that L_x comprises a resistance R_x in series too.

The moderating effect of cable's resistance is quite visible but, with normally used installation cables, often not strong enough for an adequate preservation of the intended safety factor, when combining C_0 acc. to IEC 60079-11 with cables and neglecting cables' inductance.

Note: It should be emphasized, that the worst case situation occurs at a certain (merely short) cable length.

Conclusion

Interaction of capacitive and inductive appearances will occur also, if only one partner is lumped, not only if both are. In this case, especially the combination of big lumped capacitances and (small) distributed inductances can reveal a significant safety critical influence on the yielded safety factor.

Annex B: Instant arc suppression

As presented in *ispark's* supplement main, chapter 5.2, spark's power matching is significantly time dependant, and very weak at the beginning. Upcoming new techniques do use this effect to gather more available power for cable connected devices.

Despite nowadays it's not prepared for every bodies use with this respect, *ispark's* model is able yet to perform the task to evaluate artificially influenced sparks, including the simple case of current interruption.

How instant arc suppression works

An upcoming opening spark can be detected easily because of its characteristic start voltage of about 10 V. With this presentation not shall be discussed a superior way of spark recognition, whether it's performed by current watching or high frequency detection or any other method. The only drawback considered here, is that spark detection is carried out at the beginning of the line, while spark location is at the end.

Considering the (simplified) circuit below, arc suppression will work in general as follows:

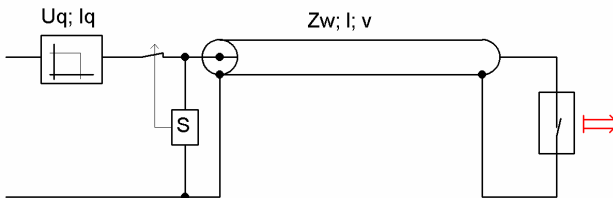

An arising spark produces an electrical wave, propagating with the speed v from its location at the cable towards cable's beginning. An intelligent switch S encounters this incident after a propagation delay of l / v (according to the actual cable length and propagation speed) and switches the power source off, causing another wave moving towards the spark location producing an effective current of zero.

At spark's location, the interrupting means has effect after a delay time of $2 * l / v$, further on called T_p . Wave's propagation speed is $v = 1 / \sqrt{L' * C'}$.

Please note, that before this moment, the spark is fed via the characteristic impedance of the cable $Z_w = \sqrt{L' / C'}$ and an active starting current I_A of $I_q - U_q / Z_w$.

Source's open loop voltage and shape stays totally hidden

Ideal spark suppression serves for hiding source's open loop voltage and shape and thus transforms, with respect to spark ignition, even a rectangular source of high voltage to a linear one with even the same short circuit current but an internal resistance of Z_w and a driving voltage of $Z_w * I_q$ only.

The principal benefit in available consumer power is based upon the superposed relations linear/rectangular source and $U_q / Z_w * I_q$.

Example

Effectiveness of spark suppression within the scope of *ispark* shall be demonstrated here via an example:

The spark shall be fed by a linear source of an open loop voltage $U_q = 38.3 \text{ V}$ and a source resistance of 100Ω . Predetermined shall be gasgroup IIC and a targeted safety factor 1.5.

ispark calculates the following plot for opening sparks without reactances:

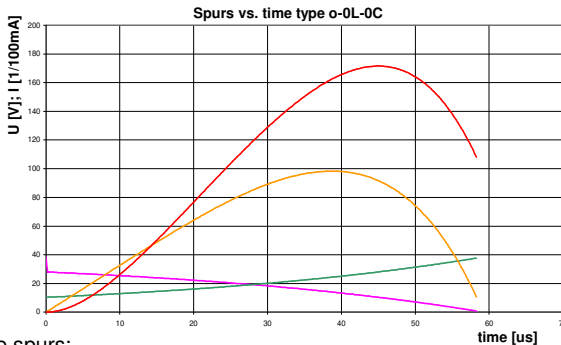

Considering the spurs:

The situation is exactly as demonstrated in chapter 6.3.2. However the arrangement is far away from intrinsic safety as the maximum temperature is about $170 \cdot 20 = 3400!$

Active starting current I_A is about 280 mA as stated above; spark's 'natural' duration is about 59 μs .

Please consider the temperature spur: its maximum is at a spark life time of about 45 μs . If there are switching means to shut down the spark current at a certain time, the maximum temperature reduces accordingly. Already here is to be seen, that such a source must be switched off at about 10 μs , to keep the allowed temperature of 520.

Instructing *ispark* to shut down current flow 10 μs after spark's beginning produces the following plot, which naturally is a cut-out of the former:

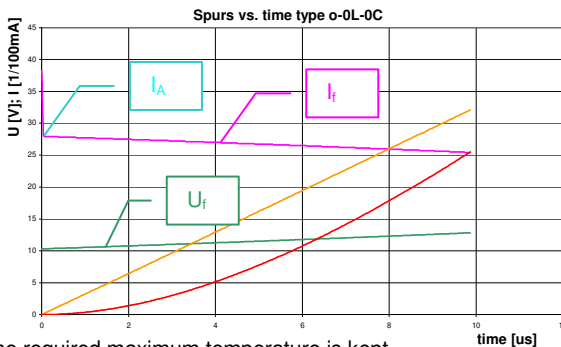

Within 10 μs , the required maximum temperature is kept.

Some more analytics

It shall be enhanced here once more:

Within the active spark duration, the source's properties with exception of the fact, that it's the origin of the current flow of I_A , stays totally hidden.

The resulting spark can 'see' only the active starting current I_A and cable's impedance Z_w . The spark evolves according to its nature with increasing spark voltage and is stopped, when current switching to zero reaches its location.

Therefore it's possible, to calculate a strict relation of active starting current I_A and permissible cable length (constituting T_p), taking the characteristic impedance Z_w as a parameter. For gasgroup IIC and a targeted safety factor 1.5, *ispark* calculates the following diagram:

(Three spurs according to $Z_w = 80, 100$ and 120 V/A)

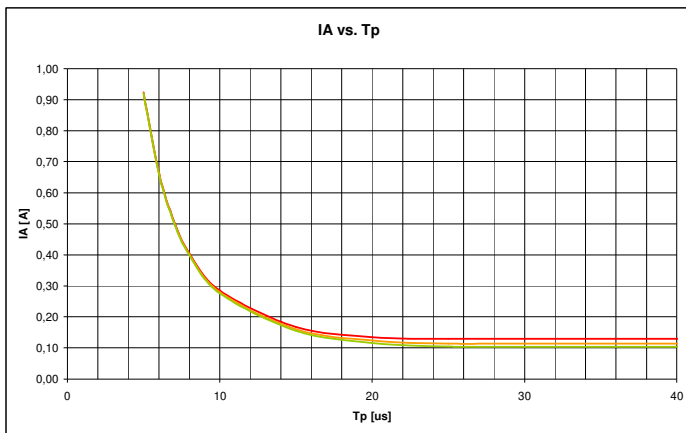

Examining the diagram, the following items become clear:

- the variation of Z_w within 80 to 120 V/A is of minor interest
- for great delay T_p , the curves approach the ohmic boundary given by Z_w as an active linear source only; within this situation, the 'natural' spark duration is effective, switching the current down comes too late
- to become really effective, switching delay must be smaller than about 14 μ s, which is associated to a little more than 1 km with common cables
- greatly more active starting current is achieved not till then, when switching delay is smaller than about 8 μ s, which may be possible with 500 m standard cable

Limits of effectiveness

Two fundamental limits have to be differed:

- a) as all considerations above concern opening sparks only, other spark types have to be regarded additionally
- b) shutdown may take some time

Concerning a):

Cables carry capacitive properties also. The benefit, not to encounter source's open loop voltage because of switching off, vanishes more or less before the background of closing sparks. Closing sparks establish an independent upper level of permissible open loop voltage.

As a result, the longer the cable, the heavier the restriction in voltage is.

Example 1:

Considering a cable with 0.6 mH/km, 0.06 μ F/km and a length of 1 km, spark type s allows an open loop voltage of about 30 V according to 0.06 μ F.

T_p is $2 \cdot \sqrt{L \cdot C} = 12 \mu$ s. With 12 μ s and $Z_w = 100$ V/A, an active starting current of 230 mA is allowed, according to the diagram above. This I_A corresponds to a permissible source short circuit current I_q of 230 mA + $U_v/Z_w = 333$ mA.

As a result, a source power of 333 mA * 30 V \approx 10 W is available for loading devices, when using a source with rectangular characteristic.

Example 2:

Reducing the intended cable length to 500 m ($T_p = 6 \mu$ s), the situation alters as follows:

- $I_{Azul} \approx 660$ mA $\rightarrow I_{qzul} = 763$ mA
- $U_{qzul} = 43$ V, corresponding to 0.03 μ F
- $P_{avail} = 32.8$ W

Concerning b):

As shutdown never can be instantaneously, an additional delay occurs.

Within this delay time, the upcoming wave at the beginning of the cable is reflected by the source, which tries to (re-) establish its original short circuit current I_q , until the current finally is switched off after a delay called T_s here. The created pulse will wander through the cable and finally reach spark's location; its level is the original I_q for a time of T_s .

For a more quantitative view, please remember the example above, using a linear source of an open loop voltage $U_q = 38.3$ V and a source resistance of 100 Ω , presented for a cable induced delay of 10 μ s.

At the time, when switching delay becomes effective at spark's location, its actual voltage is about 13 V, corresponding to a calorical net value of 13 - 10.3 = 2.7 V. If for a time span of $T_s = 1 \mu$ s, the original current I_k of 383 mA is flowing, an 'additional' energy of 1μ s * 2.7 V * 383 mA = 1.03 μ J is introduced to the spark. Comparison to the characteristic spark ignition energy of 5 μ J shows directly the contribution of this pulse as consuming about 20% of the overall ignition margin.

Conclusion

Despite *ispark* for common use is intended for undisturbed sparks, a future use is possible for evaluation of dynamically influenced ones also. At least, *ispark's* procedures do offer the possibility to detect principal chances as well as boundaries for shut down technologies.

Annex C: Low voltage battery circuits

The battery circuit itself

ispark's principal capability to cover circuits, which may be difficult to be evaluated using the standardized spark test apparatus, shall be demonstrated here by picking up low voltage battery circuits.

For gasgroup IIC, linear source and safety factor 1.5, the method *ispark* delivers the following results for high current applications:

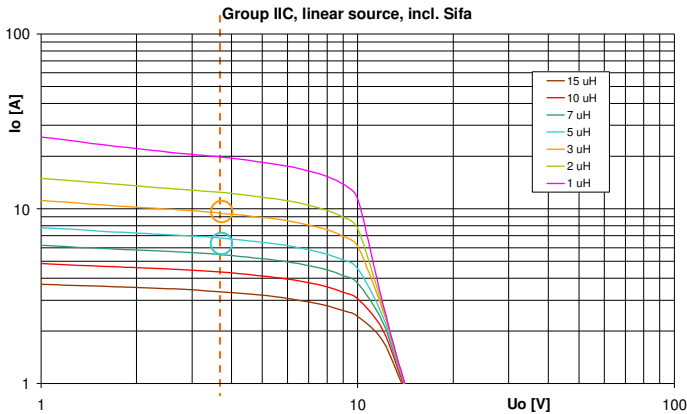

As orange dashed line incorporated is an open loop voltage of 3.7 V, taken as load voltage of a battery for portable apparatus. It's clearly to be seen, that with this low voltage, inductance plays a more decisive role than the voltage itself.

Unfortunately, the standardized spark test apparatus is allowed to have an internal inductance of up to 3 μ H (chapter B.1.2, IEC 60079-11), and surely the apparatus has some indeed. With 3.7 V and 3 μ H, according to the figure, an I_o of 9.4 A is possible, constituting an effective current limiting resistance of $3.7 \text{ V} / 9.4 \text{ A} = 0.39 \Omega$.

But the standardized spark test apparatus should have at least a small resistance too. Some former investigations pointed out a resistance of about 0.2 Ω . Thus the effective short circuit current is lessened from 9.4 A to $9.4 \text{ A} * 0.39 \Omega / (0.39 \Omega + 0.2 \Omega) = 6.21 \text{ A}$, conforming with an effective permissible inductance of about 6.0 μ H instead of 3 μ H.

The question arises, whether an artificial spark test apparatus (like *ispark*) should keep properties like L_i and/or R_i of the technical representation of the standardized spark test apparatus or this is not the target of its original intention.

From the dissertation Johannsmeyer is known, that it's possible to modify the standardized spark test apparatus via a special contact arrangement (directly to the contact disks) down to 0.25 μ H and 0.2 Ω overall resistance is a common value.

While a lasting decision isn't carried out by normative implication, *ispark* will ignore spark test apparatus' internal inductance as well as its resistance.

An additional cable

Especially with low voltage high current applications, cables carrying inductive (and resistive) aspects are of high interest. Let's follow an extended interpretation of the figure above for a circuit with an open loop voltage of 3.7 V and an overall current limiting resistance of 0.35Ω ($I_o = 10.6 \text{ A}$):

Note: The available power is 9.81 W.

The permissible inductance here is $2 \mu\text{H}$, resulting in a calculated L'/R' ratio of $5.71 \mu\text{H} / \Omega$.

In an analytical way it can be shown that, once an L/R ratio of a source is established to be intrinsically safe, it can be appended by a circuit having at maximum the double value in L'/R' .

In this case, a connected cable may have $2 * 5.71 \mu\text{H} / \Omega = 11.4 \mu\text{H} / \Omega$ without deteriorating intrinsic safety and isn't restricted in length with respect to opening sparks. Cable's C' doesn't play any significant role here.

If you, for example, use a cable of $L' = 0.35 \text{ mH} / \text{km}$ and $35 \Omega / \text{km}$, the L'/R' condition is fulfilled; the cable then may be of unlimited length. But if you really need supply power for your application, the summarized circuit resistance is counterproductive. As an absolute boundary may be considered an equal power loss in the source resistance as well as the cable's. If so, then with this cable no length is reasonable but below 10 m constituting an available consumer power of 4.91 W.

Increasing available power using electronic voltage and current limitation

More consumer power is available, if voltage and current limitation is performed by electronic means (rectangular source). To keep the relations of the example above, a rectangular shaped source of $U_o = 3.7 \text{ V}$ is predetermined and a $dU = 0.5 \text{ V}$.

For this circuit, *ispark* reports a short circuit limit of $I_o = 9.4 \text{ A}$ with an overall inductance of $2 \mu\text{H}$, resulting in a maximum L'/R' ratio of an additionally connected cable with infinite length of $2 * 2 \mu\text{H} * 9.4 \text{ A} / (3.7 \text{ V} - 0.5 \text{ V}) = 11.8 \mu\text{H} / \Omega$.

Note: The permissible short circuit current is only a little bit smaller than with the linear circuit discussed above ($I_o = 10.6 \text{ A}$).

At the source's connections directly available is a consumer power of $(3.7 \text{ V} - 0.5 \text{ V}) * 9.4 \text{ A} = 30.1 \text{ W}$.

Using a cable of $L' = 0.35 \text{ mH} / \text{km}$ and $35 \Omega / \text{km}$, the L'/R' condition is fulfilled, the cable then may be of unlimited length. But considering power dependent applications, cable's resistance does produce an obstacle, the same way as discussed above. Assuming, reasonably load and cable dissipate even the same power, some sort of power matching occurs at a length of $(3.7 \text{ V} - 0.5 \text{ V}) / 9.4 \text{ A} / 35 \Omega / \text{km} = 9.73 \text{ m}$. The maximum reasonable cable length is like the linear circuit situation but the available power is somewhat higher (7.52 W). It would be as double as high, if dU could be decreased to nearly zero.

An additional lumped capacitance

The linear circuit mentioned above, consisting of an active source and a connected cable, is able to bear additionally some lumped capacitance. This is, because capacitively dominated close/opening sparks have different properties than their pure opening counterpart. But there is no simple formular evaluation possible here.

Nevertheless, the restriction in lumped capacitance is fully equal to this one, which results out of *ispark's* lumped consideration via (!)ist. Cable's capacitance doesn't contribute in any way.

*Remark: The following presentation is for demonstration purposes and available only using *ispark* in developer mode. If there is any reasonable request, this approach will be incorporated for common use.*

Please see *ispark's* results via the command (!)ist:

```
program ispark, version 7.1, 01.04.2015 ***** copyright @ PTB 2002

zone      : 1
gasgroup: IIC
source    : linear

Uo        [V]=    3.700
Io        [mA]=10000.000
freewheeling: without

Lo[mH]    0.003   -   -   -   -   -   -   -   -
Co[uF]    88.300  -   -   -   -   -   -   -   -

Lo[mH]    -   -   -   -   -   -   0.002  0.001
Co[uF]    -   -   -   -   -   -   183.0001000.000
```

And per executing (i)include cables:

```

program ispark, version 6.0, 29.04.2008 ***** copyright @ PTB 2002

Sifa      = 1.50
gasgroup: IIC
source    : linear

Uo        [V]=    3.70
Io        [mA]=10571.43
Rd        [Ohm]=    0.20
freewheeling: without

inductance/km      [mH/km]:    0.700
capacitance/km    [uF/km]:    0.030
resistance/km     [Ohm/km]:   60.000

info: L`/R` [uH/Ohm]:  11.667;  Sqrt(L`/C`) [V/A]:  152.753

info: CazulIEC [uF] :1000.000

0.000  0.500  0.200  0.100  0.050  0.020  0.010  0.005  0.002  0.001
0.000  -      -      -      -      -      -      -      240.0001000.000
0.010  |      |      |      |      |      |      |      |      |
0.020  |      |      |      |      |      |      |      |      |
0.050  |      |      |      |      |      |      |      |      |
0.100  |      |      |      |      |      |      |      |      |
0.150  |      |      |      |      |      |      |      |      |
0.200  |      |      |      |      |      |      |      |      |
0.300  |      |      |      |      |      |      |      |      |
0.400  |      |      |      |      |      |      |      |      |
0.500  |      |      |      |      |      |      |      |      |
0.700  |      |      |      |      |      |      |      |      |
1.000  |      |      |      |      |      |      |      |      |
1.500  |      |      |      |      |      |      |      |      |
2.000  -      -      -      -      -      -      -      -      240.0001000.000
    
```

Interpretation

ispark demonstrates the mixed circuit evaluation to be sufficient; no cable related considerations are necessary here.

Conclusion

A normative implication is required, how to deal with possibly unwanted properties of the standardized spark test apparatus, especially with its internal inductance.

Annex D: Spark's energy balance

Foreword

Very early already, the imagination of a certain characteristic ignition energy was developed. IEC 60079-11, for example, denominates a value of inductively stored energy of 40 μJ with gasgroup IIC, safety factor 1.0 and linear inductive circuits in figure A.4.

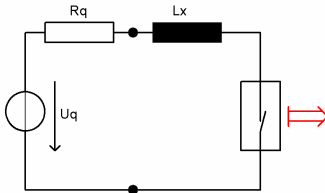

Considering the according circuit diagram, one will encounter, that the current limiting resistance naturally carries the spark current also and surely will participate in energy consumption.

Unfortunately, an investigation of the power distribution implies at least some knowledge about the current flow over time, which is not commonly available.

ispark can serve for some more understanding here. With the data $U_q = 3.7\text{ V}$, $R_q = 0.55\ \Omega$ and $L_x = 0.0044\text{ mH}$, the following spurs are created for a safety factor of 1.5:

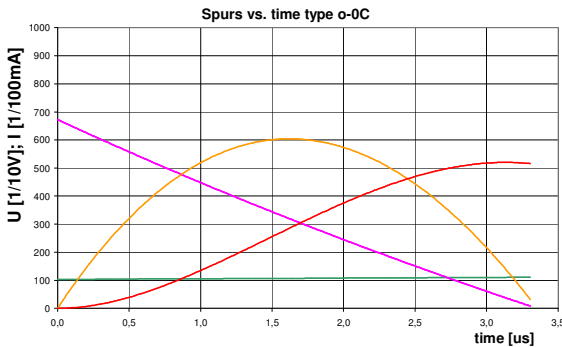

Note: scale is adjusted here to:
 voltage [1/10 V] *green*
 current [1/100 A] *magenta*
 power [1/500 W] *orange*
 temperature [°C] *red*

Considering the spurs.

There are clearly to be seen the nearly linearly falling current and only slightly increasing spark voltage. Spark's effective power course resembles a parabola and with very short sparks it will transit to one exactly. Accordingly, the temperature progress is like a polynomial of third order.

With a safety factor of 1.5, ignition boundaries are exhausted.

Energy balancing

Once the course over time is known, it's only a simple step to calculate energies and the following table results:

Naming	Formular	Value [μJ]
source spent	$U_q \cdot \int I_s dt$	39.7
inductively spent	$(U_q / R_q)^2 \cdot L_x / 2$	99.6
resistively consumed	$R_q \cdot \int I_s^2 dt$	25.8
via loss voltage consumed	$U_v \cdot \int I_s dt$	110
net spark consumed	$\int (U_s - U_v) \cdot I_s dt$	2.7

Checking spent energy against consumed one: $39.7 + 99.6 = 139 \mu\text{J} = 25.8 + 110 + 2.7$.

Spent energy participation

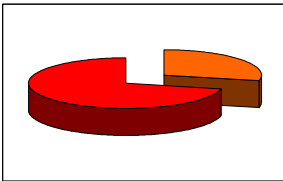

Inductance as well as the source do share significantly in spent energy. The relation is about 100 : 40 here.

Consumed energy participation

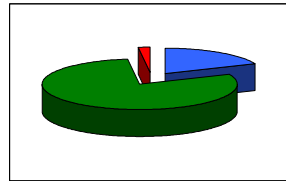

The decisive loss factor here is spark's loss voltage, consuming about 79% of the spent energy, R_q dissipates about 19% only.

The most surprising fact seems to be the tremendously weak matching of spark's net energy, which is about 1.9% of the overall delivered only.

An evaluation method, not taking into account power losses and based only on initially stored energies can be suitable only within small selected areas of electrical data, but will fail in a more general view.

Compared to the formerly common practice of evaluating a circuit out of an inductively stored energy only, a value of 99.6 μJ is possible here, which is much larger than the normatively stated $40 \mu\text{J} / (1.5)^2$. But near to the ohmic boundary, even without inductively stored energy, an ignition is possible.

Note: Please remember, that the real effective ignition energy with gasgroup IIC and safety factor 1.0 of opening sparks is 5 μJ. Taking alternatively into account a safety 1.5, this net energy decreases to $5 / 1.5^2 = 2.22 \mu\text{J}$. The difference to the value 2.7 μJ as reported above is debited to the fact, that spark's duration is not very short against the thermal time constant, which is necessary for a pure energy relationship.

Conclusion

Advanced investigations show, that the premise of a constant ignition energy can't be affixed to initially stored energies in reactances for the whole region of intrinsically safe circuits. It merely has significance for distinct areas of electrical values, but suffers from unknown limitations in validity.

ispark yet, is able to differ between losses and active constituents in spark ignition and serves for coherent results over a large span of circuits.

Annex E: Electronic current limiters

For some practical reasons, instead of current limiting resistances, electronic means are used, resulting in an effectively rectangular shaped source characteristic. A special question arises, when the electronic limiting is not perfect but incorporates some delay. This situation also *ispark* is able to deal with and further can cover reactances C_o and L_o within the circuit.

General

With respect to common used electronic current limiters, the normal problem is the transition to engaged limiting, not the release function. Therefore with pure opening sparks no special situation arises but with closing ones only. As a result, the absolute maximum permissible inductance L_{pms} is not affected by such a pulse at all, but capacitances are.

Normally with closing sparks a parallel connection of the spark test apparatus as the lowest available impedance presents the worst case.

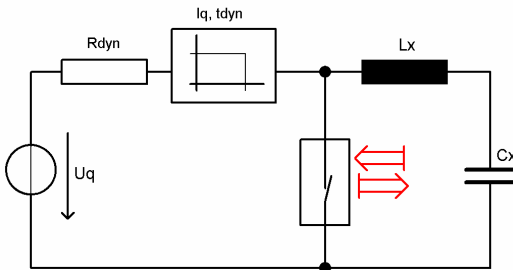

According to the figure at the left, the electronic current limiter is adjusted to a steady state current of I_q and its engaging delay is named t_{dyn} .

Up to the moment t_{dyn} , a rather small resistance R_{dyn} is active only, responsible for an initial big current pulse.

An example

As an example a rectangular shaped source is chosen with an U_o of 14 V, $dU = 0.5$ V and an I_o of 120 mA. Further general conditions are gasgroup IIC and safety factor 1.5.

As an actually effective reactance predetermined is $L_o = 0.05$ mH.

Actual C_o is chosen for demonstration purposes.

Delay 3.6 μ s, $R_{dyn} = 1 \Omega$, $C_o = 0.033 \mu$ F

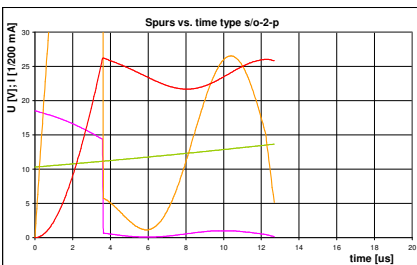

Perfect current limitation, $C_o = 0.533 \mu$ F

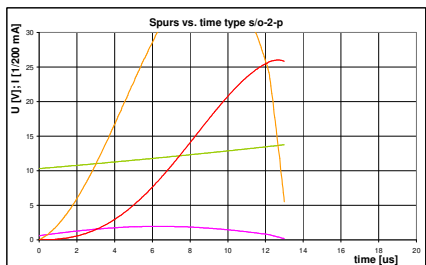

Considering the spurs:

Both plots show a maximum temperature (red line) of about 520 according to ignition boundary. The difference is, how energy is introduced into the spark. If there is no puls, most introduced energy arises from the charged capacitance, not the source itself:

$$(14 \text{ V} - 10.3 \text{ V})^2 \cdot 0.533 \text{ } \mu\text{F} / 2 = 3.65 \text{ } \mu\text{J}.$$

If there is a pulse, with $R_{dyn} = 1 \text{ } \Omega$ and a delay time of 3.6 μs , this initial puls itself creates a very instant temperature rise to 520. Only because reactances need some time for to become efficient, there is any room for further energy introduction. In some kind of basic understanding, this behavior is a result of minor time correlation of participating effects.

With this example, the initial pulse does consume most of the safety margin, leaving as permissible a $C_o = 0.033 \text{ } \mu\text{F}$ only, according to an initially stored energy of 0.226 μJ .

The dependence of permissible capacitance C_o ($L_o = 0.05 \text{ mH}$, $R_{dyn} = 1 \text{ } \Omega$) versus puls width is like follows:

puls [μs]	3.6	3.5	3	2	1	0.5	0.2	0.1
C_o [μF]	0.033	0.139	0.272	0.420	0.504	0.526	0.532	0.533

As without any puls *ispark* determines $C_o = 0.533 \text{ } \mu\text{F}$, pulses up to 1 μs do have nearly no effect.

Some further investigations show, that delays with electronic current limiters of not more than 1 μs pulse duration do not minder permissible capacitances C_o by more than 2% if the medium pulse current does not exceed ten times the regulated short circuit current.

Conclusion

Picking up pulse features isn't a problem for *ispark* at all.

However, modern electronics are able to keep pulses very short. Therefore, and to keep *ispark's* operating simple, an external evaluation procedure will be appropriate (please see below).

Rational extension procedure

For rationally designed electronic current limiters (max. 1 μ s and max. 10 * I_o) there is found to be no need to take dynamic properties into account at all.

If there are any doubts however, a quantitative estimation is possible using short circuit testing of the active electrical source itself (without any external load).

Note: It's urgently recommended to use an electronic device of sufficient current capability for short circuiting. Metallic contacts reveal unexpected effects like a threshold voltage and an undefined short resistance.

Measuring results may be similar to Figure E.2, IEC 60079-11, current in red color, Voltage in blue:

– 120 –

60079-11 © IEC:2011

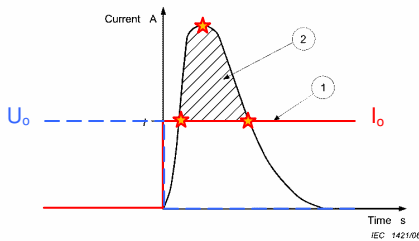

Key

- 1 / is equal to the maximum permitted current by spark test or Annex A
- 2 Transmitted energy (in Joules) = V (in volts) x hatched area of the curve (in A*s)

Figure E.2 – Example of output waveform

ispark directly considers current and voltage according to the colored spurs.

What's left here, is to take into account the hatched additional current overshooting area.

Here's an example for ispark's regular output for a rectangular source:

```

program ispark, version 6.2, 28.11.2012 ***** copyright @ PTB 2002

zone      : 1
gasgroup: IIC
source    : rectangular

Uo        [V]= 16.000
Io        [mA]= 50.000
dU        [V]= 0.500
freewheeling: with output

Lo [mH]  1.400  -      -      -      -      -      -      -      1.000  0.500
Co [uF]  0.230  -      -      -      -      -      -      -      0.270  0.280

Lo [mH]  0.200  0.100  0.050  0.020  0.010  0.005  0.002  0.001
Co [uF]  0.280  0.330  0.390  0.460  0.460  0.460  0.460  0.460
    
```

Let's assume, the pulse characterized by the three stars within the figure above has a duration of 1 μ s and an amplitude of 1 A and may be similar to a sinus shape.

Then, while short circuiting, a charge is flowing of about (I_0 of 50 mA neglected) $1 \mu\text{s} * 1 \text{ A} * 2/Pi = 0.637 \mu\text{C}$.

Combined with an open loop voltage of the source of 16 V this is equivalent to a capacitance of $0.637 \mu\text{C} / 16 \approx 40 \text{ nF}$.

This capacitance can be treated as an (additional) internal capacitance C_i of the source and shall be subtracted from those overall permissible capacitances presented in *ispark's* listing.

Example:

For an L_0 of 0.050 mH, instead of the original value of 0.390 μF , an effective overall capacitance for the external circuit of $0.390 \mu\text{F} - 0.040 \mu\text{F} = 0.350 \mu\text{F}$ is appropriate.

Conclusion:

Although the current pulse's peak is twenty times the stationary value, it will cause nothing more than to minder the permissible overall capacitance by about 10%.

Even if this effect would not be considered, it will be well enclosed by the required safety factor 1.5.

*Note: The difference between the procedure presented here, using *ispark's* methodology and the standard's one mainly is, that the latter claims an energy only as decisive, while *ispark* sophisticatedly takes into account further items, for example spark types and a well established loss voltage.*

Annex F: *ispark* with more complex situations

General

Despite the initial attempt of *ispark* to evaluate L_o/C_o with respect to field circuits connected to one or more associated apparatuses, it's applicable for further assessments also.

Finally there is no difference for any spark, irrespectively in which location it occurs.

At first, please remember the following figure presented in *ispark's* operating instructions:

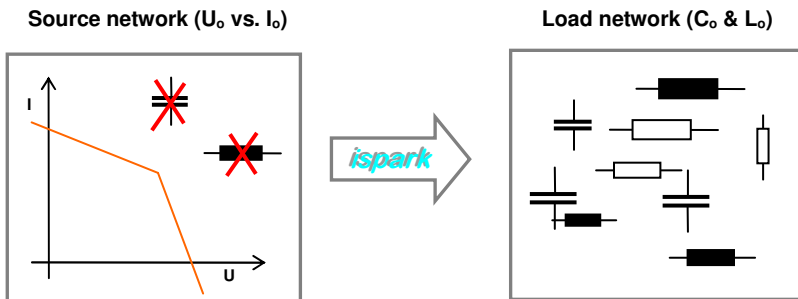

What *ispark* originally does, is to pick up the activity of a source network without reactances, determine whether or not it's intrinsically safe itself and calculate maximum C_o and L_o of an otherwise passive load network. Basis is a set of four quantitative electrocalorical spark models (types: δ , $s/\delta-1$, $s/\delta-2$ and s) serving for an exhaustive approach with respect to all actual acknowledged ignition data and are properly verified.

Note: Further insight could be provided only as result of great effort in further baseline investigations and cannot be expected in the near future.

Real situations, not simply covered by *ispark's* separation requirements with respect to included inductances and/or capacitances, requires some further reflections.

If an Associated Apparatus does reveal L_i and/or C_i

It can be demonstrated, that it's safe to transfer calculatory present internal inductances and/or capacitances of an actual source network into the load network. This course of action follows the normal procedure with the entity concept of intrinsic safety and is no speciality of *ispark*.

This obviously is correct with reactances situated directly at the output connections, for example for EMC purposes. Because they usually are very small, this will not result in severe restrictions. If they are not, preferably the circuit design should be revised.

First Example

Preliminary

Fig. 1 characterizes the standard situation consisting of a single source network block Q - without reactances and with infallibly established electrical activity - and a passive network block A, comprising reactances in arbitrary arrangement and failure conditions.

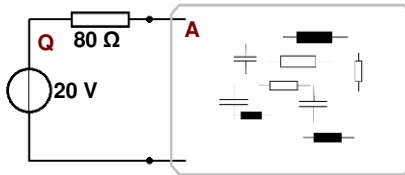

Fig. 1

The only thing to do is to provide *ispark* with the data of the source (20 V and 80 Ω) which results in e.g. $C_o = 0.22 \mu\text{F}$ and $L_o = 25 \mu\text{H}$. If this condition is fulfilled by C_i and L_i of block A then nothing further is to do, intrinsic safety is approved for the whole arrangement. C_i and L_i however do appear from a safety point directly at the source's connections also.

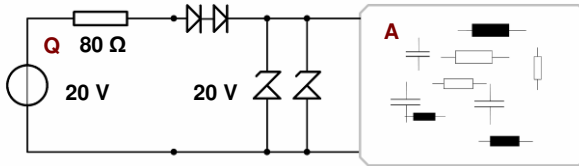

Fig. 2

Within Fig. 2, an attempt is shown, how to minimize C_i and L_i of block A to nearly zero. diodes will prevent capacitive energy backward flowing from block A to block Q and zeners do freewheel, such that an outer inverse voltage should be neglectably small. This is also with combined inductive/capacitive outcome. In effect, the so formed "barrier" is of a mono-directional kind, id est, segregation in opposition with respect to power flow only. Neither C_i nor L_i does appear at the source's connections.

In the following, the evaluation of a more complex circuit arrangement is demonstrated.

Some preliminary notes referring to this example's presentation

To keep volume rational for even the intended target of assessing spark ignition properties, the presentation does not comprise necessary features like infallible segregations or all required infallible connections. Components are treated in a somehow idealized manner (e.g. threshold voltages) and rating of components isn't within the actual scope. Those properties should be deduced from the way of conclusions.

Furthermore numbers are chosen for demonstration purposes, not for an overall intelligent operation at the whole.

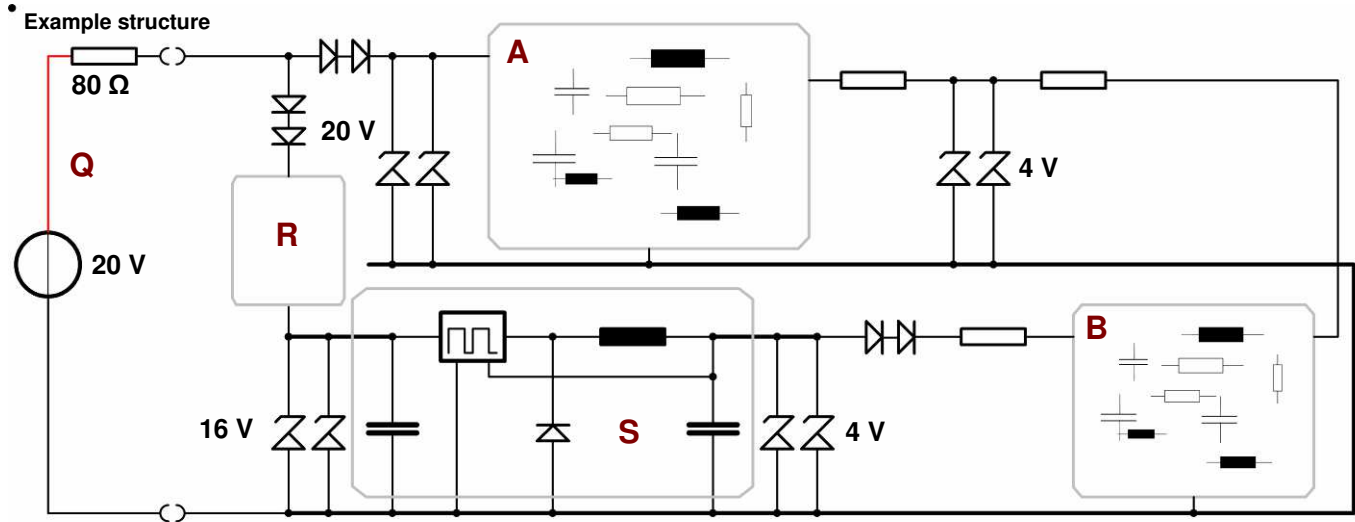

The circuit presented consists of one active power source (block Q), one for analog processing at 20 V (block A) and another one for digital functions operating at 4 V (block A). A converter block S serves for some more efficient power conversion from 20 V (16 V) down to 4 V. Block R doesn't perform safety relevant tasks, however it's not including reactances. Between blocks, some segregation means are situated, targeting to limit mutual reactive influences of associated blocks in a sufficient manner. Blocks A and B are passive (power consuming only) but with safety aspects, are fed by two sources, while block S is designed to transfer power only in one direction.

Please see, within this example, the only circuit part, which is not dedicated to and cannot be intrinsically safe is the red enhanced one.

Note: The commonly used entity concept with intrinsic safety, defining L_o and C_o with active sources and reverse "load" block action by L_i and C_i is a very simple approach. It's hardly expressive if the latter itself comprises limiting means and/or has any transconductance to further active sources.

Example evaluation

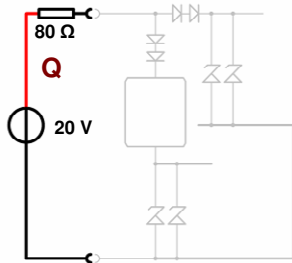

At first, the pure power source block Q is to be evaluated

$U_o = 20\text{ V}$ and $R_v = 80\ \Omega$ with linear characteristic and gasgroup IIC, according to *ispark* results, for instance, in the pair $L_o = 25\ \mu\text{H}$ and $C_o = 0.22\ \mu\text{F}$. But the design intention here shall require some more simple sum of capacitance and additionally includes a current converter.

One of these items already makes further assessments necessary.

Note: You cannot place any C or L parallel the source network without having to consider their punch-through into the subsequent blocks. If you urgently need some small ones however, you may perform a second course of calculation refining those data found by leaving them out.

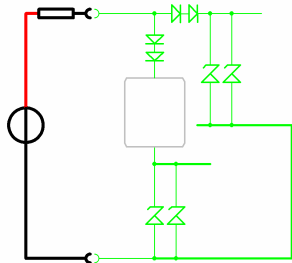

Decoupling considerations

Because operational blocks A and B - with this example - are assumed to be very different in voltage and capacitive requirements, designers idea is to split the power path into two independant branches.

Inserted limiting means serve for mutual decoupling reactances of block A and B one from the other and the source too. Diodes in series prevent from backward current flow and zeners via freewheeling from the addition of significant reverse voltages (they additionally limit inductive overvoltages eventually compromising diode's rating). In effect, with respect to the source network also, the load is not reactive at all ($C_i \approx 0, L_i \approx 0$).

Note: Splitting in this manner is an easy way, however in each subsequent blocks the full source activity has to be taken as safety relevant basis. If possible one should assign a seperate limiting resistor to every block.

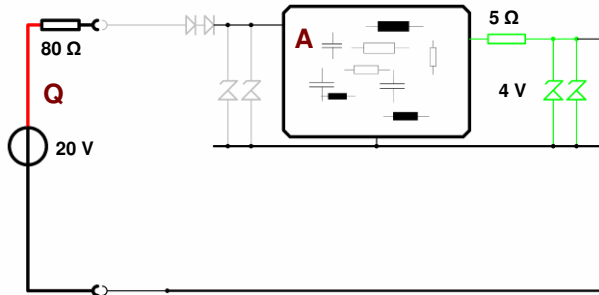

Now considering block A:

From the left, block A is fed from the linear source network according to 20 V and 80 Ω. Additional there is a second input via limiting means constituting an additional linear source with an $U_o = 4\text{ V}$ and a source resistance $R_s = 5\ \Omega$.

In this case of a “multiple source” dual parallel connection *ispark* calculates permissible capacitances $C_i = 0,22\ \mu\text{F}$ and $L_i = 21\ \mu\text{H}$ overall within block A in arbitrary connection.

Note: Despite via $U_o = 4\text{ V}$ at a source resistance of $R_s = 5\ \Omega$ the maximum internal current significantly rises from $20\text{ V} / 80\ \Omega = 250\text{ mA}$ to 1050 mA , allowed inductance L_{perm} will decrease but not of the same amount.

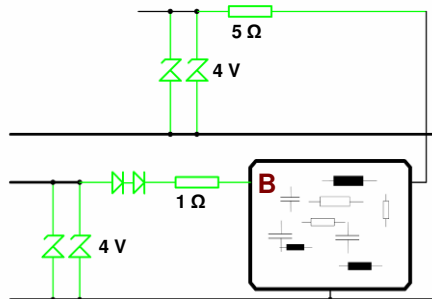

Block B:

From the left, block B is fed from the linear source network according to 4 V and 1 Ω. Additional there is a second input via a limiting means constituting a linear source with an $U_o = 4\text{ V}$ and a source resistance $R_s = 5\ \Omega$. Both sources are arranged in parallel connection.

ispark calculates permissible capacitances $C_i = 600\ \mu\text{F}$ and inductances $L_i = 1\ \mu\text{H}$ overall within block B in arbitrary connection.

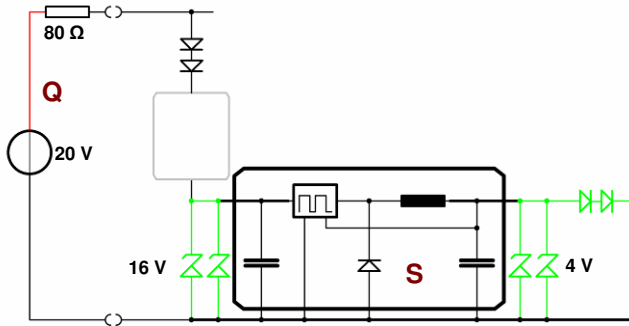

Block S:

Feeding of block S is via block Q only because of limiting components arranged at the output.

Segregating input zeners will moderate the efficient source from 20 V and 80 Ω to a trapezoidal one with $U_o = 16\text{ V}$, $R_{\text{eff}} = 80\ \Omega$ and $I_o = 250\text{ mA}$. *ispark* calculates permissible values of, for example, 0.46 μF & 10 μH with this situation.

The only way, input and output capacitance can be paralleled with safety metrics is associated to a common voltage of 4 V only.

The active source of this arrangement will be trapezoidal as stated above with the difference of $U_o = 4\text{ V}$ (instead of 16 V). *ispark* calculates permissible values of, for example, 25 μF & 10 μH with this situation.

In effect, permissible within block S are an input capacitance of 0.46 μF and an output capacitance of 25 μF – 0.46 μF ≈ 24 μF.

Note: Switching arrangement may transform steady state current levels but isn't able to increase reactive appearances above those described above.

Summary Within this example, several times permissible values have to be determined. Some of these tasks may be performed using other methods but if you try out, using *ispark* serves for a lot more speed and comfort. And *ispark* offers a uniform and clearly arranged technic minimizing the risk of mistakes and further facilitating documentation requirements.

Additional remark With the objective of maximum clarity, this example splits in rather weak defined blocks and dedicated limiting means arranged between them. With real circuits often there is a chance to take into account moderating effects within the “blocks” also. For example it may possible to identify a safety relevant load characteristic of the converter block S. Then the proposed modelling using 4 V and 1 Ω in block B direction can be overridden, however leaving out the latter will make converter’s output capacitance effective in block B also.

Second Example: Pure and resistively limited capacitances

With intrinsically safe apparatus often found is the situation of internal voltage limiting (U_z) and some ‚naked‘ capacitance parallel to some resistively influenced ones.

Note: Please see, that the scope is restricted to that places here, the spark test apparatus directly is connected to.

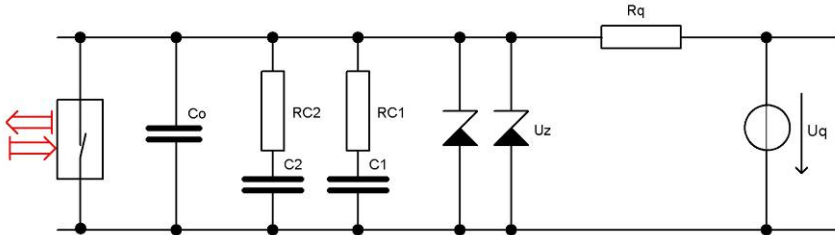

Course of run

Normally U_q as well as U_z and R_q are established primarily because of functional requirements. All together, they form a trapezoidal source characteristic.

First step

Evaluate the static trapezoidal source of U_q , R_q and U_z using *ispark* (28 V, 140 Ω , 10 V):

```
program ispark, version 7.1, 27.08.2015 ***** copyright @ PTB 2002
```

```
EPL      : b
gasgroup : IIC

source   : trapezoidal
Uo       [V]= 10.000
Io       [mA]= 200.000
Rq       [Ohm]= 140.000
freewheeling: with output
```

```
SafetyFactor: 23.00
```

Lo[mH]	0.600	-	-	-	-	-	-	-	0.500
Co[uF]	0.470	-	-	-	-	-	-	-	0.540
Lo[mH]	0.200	0.100	0.050	0.020	0.010	0.005	0.002	0.001	
Co[uF]	0.930	1.300	1.700	2.400	3.000	3.000	3.000	3.000	

As the target circuit doesn't have significant L, one may assume some more short circuit current to be available.

Second step

Introducing an additional linear source in parallel with an open loop voltage of $U_z = 10\text{ V}$ (according to the conditioned open loop voltage of capacitances of interest) and a short circuit current of 4.8 A results in:

```

program ispark, version 7.1, 27.08.2015 ***** copyright @ PTB 2002

EPL      : b
gasgroup : IIC

2 Sources connected in parallel

1 trapez.: Uo [V]=10.000; Rq[Ohm]= 140.000;          Io [mA]= 200.000
2 linear  : Uo [V]=10.000;                          Io [mA]=4800.000

SumI:
Ue [V]  10.000  9.500  -
Ie [mA]  -      372.1435000.000

Lo [mH]  0.004  -  -  -  -  -  -  -  -
Co [uF]  3.000  -  -  -  -  -  -  -  -

Lo [mH]  -  -  -  -  -  -  0.002  0.001
Co [uF]  -  -  -  -  -  -  3.000  3.000
    
```

Already, with this insight, a ,naked' C_o of 3 μF is possible.

Note: Please see, that procedures like this aren't straight forward but require some ingenious stepwise operation.

Third step

If at the place of consideration the requirements for ,naked' capacitances C_o are fulfilled, the only item left is the short circuit current driven by further capacitances damped by resistances.

According to the *ispark* calculation an additional current originating out of a parallel connected linear source of 4.8 A is possible.

Please check, whether or not the parallel connection of all resistances R_{Cx} complies with this short circuit current requirement. If so, nothing further is to do.

Fourth step

If the third step isn't successful at once, you should examine, whether or not it's profitable to shift a damped capacitance to a ,naked' one.

If there is no sufficient room to do this, the proof will fail.

Conclusion

A skilled operator premised, *ispark* can be used for internal apparatus' evaluation also; the main challenge consists in circuit abstraction (and convincing further parties like testing houses).

Annex G: Systematics of minimum ignition data

There could be a great progress in explosion protection, if it would be possible to establish the idea of an “ignitability” as a single characterising property of a mixture in question as some kind of excess of burning generated energy over propagation consumed one.

If one accepts some trivial dependences scaled to the apparatus actually in scope additionally, “ignitability” can be identified to be associated closely with the known item “quenching distance”.

As a result, those considerations may allow some characteristics transfer between different gasgroups and facilitate picking up issues like increased pressures and temperatures.

Known ignition data vs. quenching distance Q_{dist}

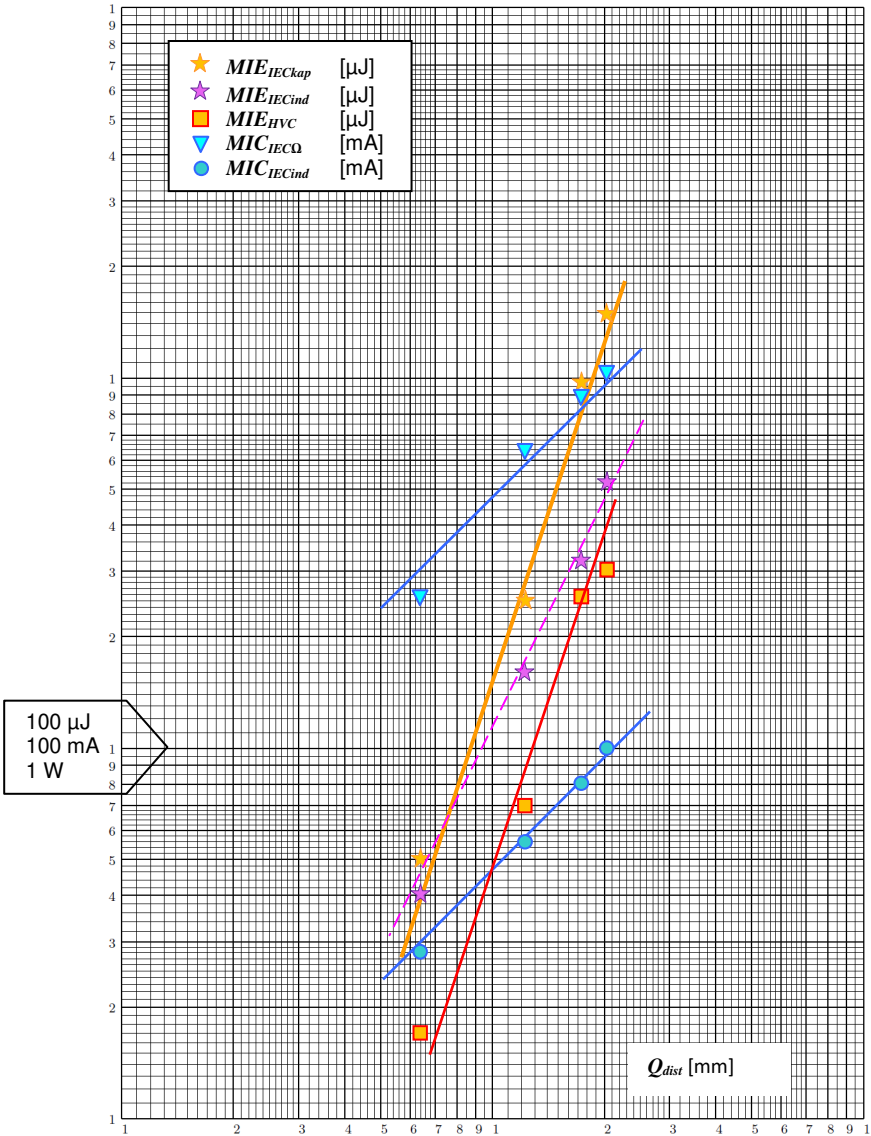

Gasgroup	IIC	IIB	IIA	I
Q_{dist} [mm]	0,64	1,22	1,75	2,03

Legend:

- MIE_{IECcap} [μ J] minimum capacitive ignition energy according to IEC 60079-11
- MIE_{IECind} [μ J] minimum inductive ignition energy according to IEC 60079-11
- MIE_{HVC} [μ J] minimum ignition energy with high voltage capacitive discharge
- $MIC_{IEC\Omega}$ [mA] minimum ignition current with ohmic sparks at 24 V according to IEC 60079-11
- MIC_{IECind} [mA] minimum ignition current with inductive sparks using 100 mH at 24 V according to IEC 60079-11

General

The expression “Quenching Distance” Q_{dist} is used in some relationship with a “Minimum Ignition Energy” MIE_{HVC} . Taking specified ignition boundary values of IEC 60079-11 into account, Q_{dist} reveals a more powerful meaning as an overall “ignitability” of a certain explosive mixture with electrical sparks.

Observations

- MIE_{IECcap} and MIE_{HVC} nearly follow cubical dependence with Q_{dist} , both MIC_{IECxxx} a linear rule and MIE_{IECind} a quadratic one.

The data gained by the original apparatus for determining Q_{dist} and MIE_{HVC} and those using the IEC standardized spark test apparatus differ only in an amplitude but not in shape.

In effect, mixture ignition properties are reduced to one parameter Q_{dist} only.

What’s left are scaling factors typical for the used apparatus and distinguishing between relevant spark types.

Interpretation

- The direct dependence of minimum ignition energies MIE_{xxx} of different gasgroups with Q_{dist}^3 is presented by several research work and based on the idea of a minimum ignition volume.
- While MIE_{xxx} belong to sparks with a very short duration, MIC_{IECxxx} do not. This directly suggests a complement to a minimum ignition energy in form of a minimum ignition power and based on the imagination of a thermal resistance to a far distance.
- With the quadratic behaviour of MIE_{IECind} an interpretation is somewhat more complex. Effectively, an evolving spark doesn’t notice an originally stored energy here but something like an impressed current. This minders the noticed square rule to a linear one.

However, where explicit values are given by standards for explosion protection, the quantitative precision achieved with those general rules cannot be sufficient for direct application to assessment procedures. Nevertheless they may serve for some more efficiency when evaluating the properties of further explosive mixtures and/or the influence of higher pressure and/or temperature and even different contact properties. One may concentrate with experimental investigations to characteristic main parameters, instead of measuring a large range of similar circuits.

ispark picks up the aforementioned basic relations within its structure and provides best fit parameters according to the standardized spark test apparatus’ results according to IEC 60079-11. A great benefit is taken from the found possibility to transfer proportions between different gasgroups.

Annex H: Statistics of ignition processes

Statistics always have a significant influence on ignition processes. The experienced spread of data depends on the used apparatus serving as ignition source, but there is a natural fluctuation with the flame progress itself.

With protection of type "intrinsic safety" 'i' it's demonstrated, that the standard's experimental assessment procedure in principal has a lack of repeatability while safety issues normally are kept.

Spark test apparatus' (STA) inherent idea:

The STA's inherent idea is such, that a more ignitable configuration will ignite earlier, a less one later. Using a fixed test sequence, the chances to pass resp. fail behave accordingly.

This is obviously correct, although in a strict way, if the term normally is added only.

STA's operating conditions are kept as constant as possible. This directly implies the idea of a constant ignition probability.

The following is intended to demonstrate how far the standardized spark test procedure meets the requirements of dependable type testing.

Spark testing using the standardized spark test apparatus:

Standardized spark test is performed by providing the adequate gas mixture, connecting the device under test (DUT) having the scheduled safety factor applied, and start the apparatus' motion. If no explosion occurs while executing up to 400 revolutions the test is passed otherwise the DUT is refused.

Some basic statistical considerations

Not mentioned but nevertheless true is the fact, that standard's stated limiting curves and tables are based in an ignition probability of about $w = 10^{-3}$ per spark.

Let's take a configuration conforming to this ignition probability 10^{-3} and processing the spark test procedure.

Every spark (the first one also) will not cause an ignition with the probability of $(1 - 10^{-3}) = 0.999$. The probability to survive a second spark also will be 0.999^2 and further 0.999^n with a series of n sparks. The chance, that sparks from the first to the 1000th do not ignite is about 37%.

Please note: From an analytical point of view, there is no difference between the practice counting from starting the STA until ignition occurs and continuing and counting the sequences between ignitions, apart from an increasing dependability with an increasing number of experiments.

The relationship, number of sparks n between ignitions and the corresponding probability p experiencing such a number, follows a cumulated exponential distribution, here called "survival probability":

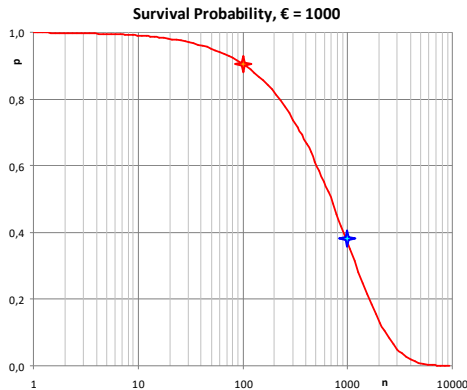

As stated above, the probability to reach 1000 sparks without ignition is about 37%. But please see also, about 10% of trials will fail within the first 100 sparks, which is far away from the expected value.

An example out of IECEx Test Round ‘i’

All data from participants according to circuit C₁ are superposed to the following diagram:

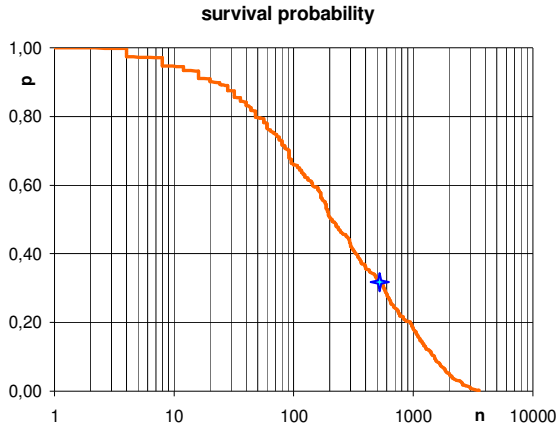

Obviously the shape resembles the one shown above, the overall mean value **n** = 508 is enhanced. The plot is somewhat expanded in horizontal direction though. This deviation is debited to its origin as a composite of measurements carried out by several testing houses yielding slightly different ignition probabilities.

An expressive example

Just consider a configuration with an ignition probability of 10^{-3} and try a first test **A** up to 1000 sparks (resp. 250 revolutions) of the STA.

As showed above, the test **A** will fail by ignition with a probability of 63%.

Let’s carry out a subsequent test **B** immediately, using even the same configuration.

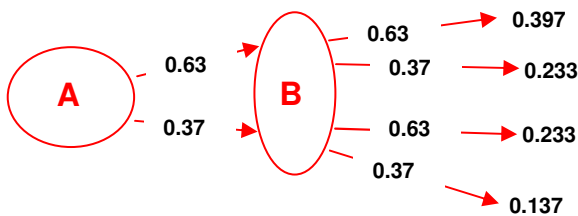

Comparing the results of test **A** and test **B**:

The probability to get the same result with both tests is 0.397 (fail) + 0.137 (stand) = 0.534, while the counterpart, different results, has a probability of $2 * 0.233 = 0.466$.

Obviously there is no essential distance between.

Note: Please see, that this weakness is even the same with the scheduled control circuit. It vanishes only, if the ignition probability of the circuit under test is very great or very small with respect to the test sequence and this situation isn’t a realistic one for type testing.

Rating test results

It was shown above, that it cannot be expected, standard's experimental procedure using one sequence upto ignition will produce a quantitatively dependable outcome.

According to an exponential distribution, the χ^2 function allows to estimate the likelihood of yielded precision in estimating the true value of ignition probability p_{zw} on the basis of the calculated mean p_{zv} arising from a number n of experiments from start to ignition.

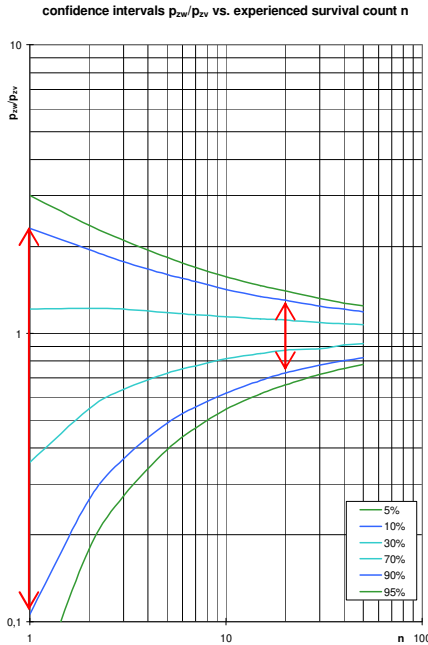

Obviously, one single experiment does not allow any reasonable quantitative conclusion at all: the value of an estimated relation p_{zw} / p_{zv} which is associated to a confidence level of 80% ranges from 0.12 upto 2.3.

Even if 20 experiments until ignition are carried out, the remaining uncertainty with ignition probability is about $\pm 25\%$.

In all cases however, the calculated p_{zw} / p_{zv} tends to be underestimated, which lies on the safer side.

Common dispersion of test results

Recently an international Test Round 'i' was processed, giving a chance to demonstrate ignition statistics on the base of a great lot of experiments comprising about 30 test institutes, everyone assessing 12 circuits 20 times.

This kind it was possible, to allocate to each testing house a typical deviation from the overall mean of results. Please see them as a lognormal distribution shown by the figure below at the left. Using the same circuits, the figure at the right demonstrates a similar relationship but in terms of repeatability with measurements conducted by one single test station (PTB).

Normalized Dispersions

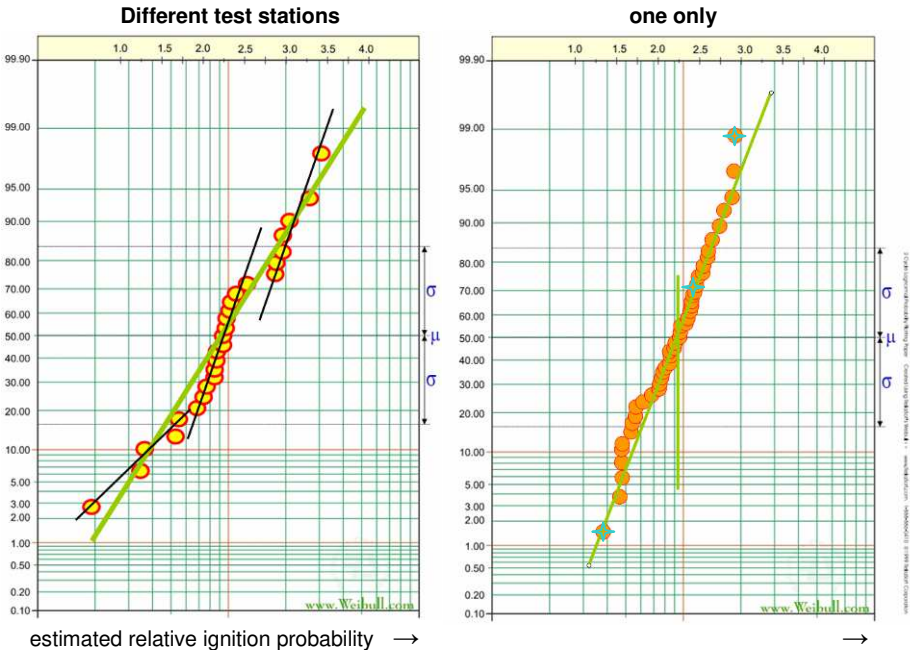

Note: A dispersion coefficient denotes the deviation where statistical significance arises. With different test houses, a dispersion coefficient of about 2 is observed, with one only, it's rather at 1.5. This isn't very dramatic.

Note: An actual dispersion coefficient depends on the type of circuit also. The dispersion coefficient of inductive circuits normally is associated with about the square of ohmic resp. capacitive ones.

What's with other ignition experiments?

Some people believe, statistics with ignition experiments are typical for the STA only.

This isn't true at all:

If one reviews experiments targeting the ignition capability of high voltage capacitive discharges (MIE) or flame transmission testing according to type of protection 'flameproof enclosure' 'd' there is a stochastically influenced transition area from ignition to no ignition also. And this is, although there are no moved parts involved.

Further investigations advise, ignition stochastics beneficially can be described by a lognormal distribution. Doing so, the characteristic dispersion coefficient of ignition probability with MIE determination and flameproof 'd' tests lay around the number 1.3 while with 'i' and ohmic or capacitive circuits it is about 1.6.

What remains is: stochastics seem to be a property of the ignition process as it's own also.

Conclusion

Statistics with ignition have to be divided into two portions:

- primarily, an exponentially shaped "filter" obscures the view
- secondly, the ignition process itself reveals a lognormal characteristic

Mainly because of the first item, there is no chance at all for STA's improvement by construction or operational conditions to achieve reasonable repeatable type testing results.

Note: If the lognormal characteristic of the ignition process is known and the ignition activity of a series of sparks each separately can be detected, it's no longer necessary to extend the test procedure until an ignition occurs but to a sufficient amount of samples of ignition activities only.

The only really feasible way is to dedicate the STA for data mining only and allocate the task of type testing to analytical methods like *ispark*. Even when done so, a lot of experiments have to be carried out for fixing quantitatively dependable results.

On the other hand side, despite the reported uncertainties of experimental testing, with type of protection 'intrinsic safety' 'i' the prescribed inclusion of a safety factor 1.5 normally will keep safety issues sufficiently.

What's left, are non consistent experimental results, inducing conflicts while type testing.

Annex I: Aggravated ambient conditions

Standard's ignition data correspond to "atmospheric conditions", which are defined by a maximum pressure of 110 kPa and 60°C respectively. This will include neither deep mines or transporting processes nor commonly found process conditions on sites.

Unfortunately, known data are rare, but taking into account the findings of Annex G, "Systematics of minimum ignition data", they can reasonably be expanded to cover the range of interest.

Please see results of Thedens compared to *ispark* at 0.3 Mpa:



Bild 3-1: Zündgrenzkurve ohmscher Stromkreise für das Wasserstoff/Luft-Gemisch bei Variation des Gemischdruckes p_f



Bild 3-5: Zündgrenzkurven induktiver Stromkreise für $U_z = 24$ V bei verschiedenen Gemischdrucke p_f

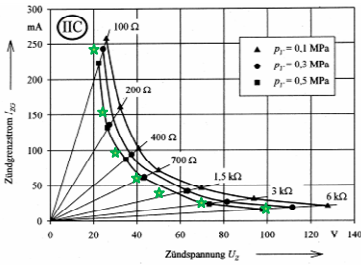

Bild 3-4: Zündgrenzkurve für $L = 1$ mH bei variablem Gemischdruck p_f

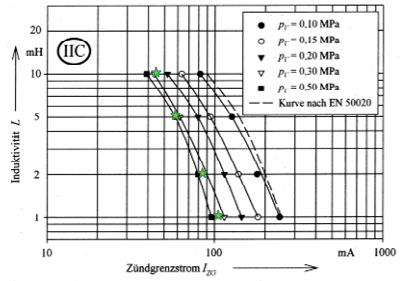

Overall, *ispark's* approximation meets the target with Thedens and gasgroup IIC. Further investigations show, this holds for gasgroup IIB as well.

Figure 2

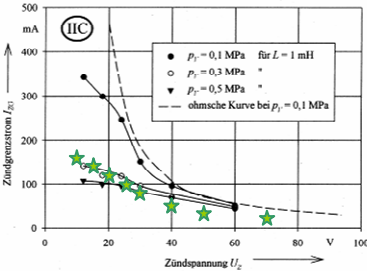
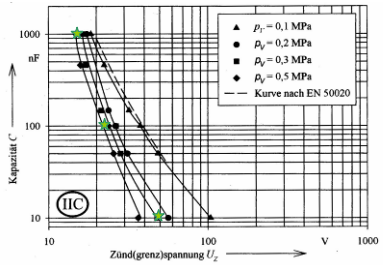
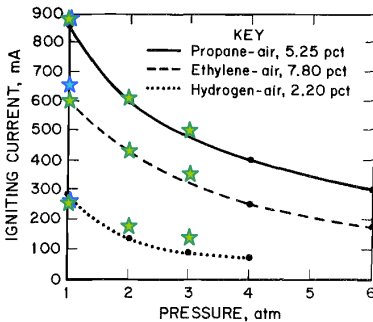

Effect of pressure on igniting current. (Reprinted by permission of Instrument Society of America, from *Electrical Instruments in Hazardous Locations, Third Revised Edition*, Copyright 1978.)

And according to literature gasgroup IIA also. With gasgroup I no data were found, it seems highly reasonable to treat it like the others.

Table 1.—Effect of temperature on minimum igniting current

Mixture, %	Minimum igniting current, mA	
	20 °C	200 °C
Ethylene-air, 7.8 . . .	600	500
Hydrogen-air, 2.2 . . .	280	200
Propane-air, 5.25 . . .	850	800

ispark ohmic:
 IIB: 502
 IIC: 191
 IIA: 797

Source: Instrument Society of America. From *Electrical Instruments in Hazardous Locations, Third Revised Edition*. Copyright 1978; reprinted by permission.

Nothing to be discussed here.

Conclusion

Obviously *ispark* maps available data with pressures upto 0.3 MPa and 300°C with sufficient precision. This is of high importance, especially because carrying out experiments with this environment conditions would require an extreme effort hardly available by common testing stations.

Annex J: Imperfections of Components

under construction

Annex K: Very high voltages

Sometimes there are questions about the situation with higher open loop voltages (U_o) than the number of 50 V, *ispark* for customers does evaluate.

Within this area, inductances play a minor role and additionally there is no significant aggravating effect of combined inductances and capacitances. What's left are ohmic opening sparks type δ -0L-0C and capacitive closing ones type s-0L, which are separated and do not effectively infer.

Therefore it's possible to reveal very simple rules for this intent as direct approximations from ignition data incorporated in IEC 60079-11 as diagrams A1, A2 and A3.

Facing the accuracy of this simplification (please see diagrams below), there is no need for an implementation in *ispark* really.

Result is:

For voltages above 50 V and linear sources, the simplification refers to an available power P with ohmic sparks and a stored energy W with capacitive ones:

	IIC	IIB	IIA	I
$W [\mu J]$	40	450	1300	3200
$P [W]$	0,5	1,2	1,5	1,8

You may include a loss voltage of 10 V for more precision but if you don't, it will be on the safe side. But urgently apply the required safety factor of 1.5 linearly with P and quadratically with W if EPL is ib or ia.

Note: The reported W are significantly higher than energy data like MIE and IEC 60079-11 with respect to "piezo", "crowbar" and "inductances". This is because with spark type s electrodes are very close together and there is a significant thermal loss of induced electrical energy.

Limitations

Approximations of W and P surely hold up to 400 V according to the data presented in IEC 60079-11.

The following inductances will be neglectable in conjunction with P mentioned above (for voltages higher than 50 V):

	IIC	IIB	IIA	I
$L [mH]$	2,5	5,0	10	20

Looking into IEC 60079-11, capacitive ignition (gasgroups IIC, IIB and IIA) is demonstrated in Figure A.3, ohmic in Figure A.1 (all gasgroups).

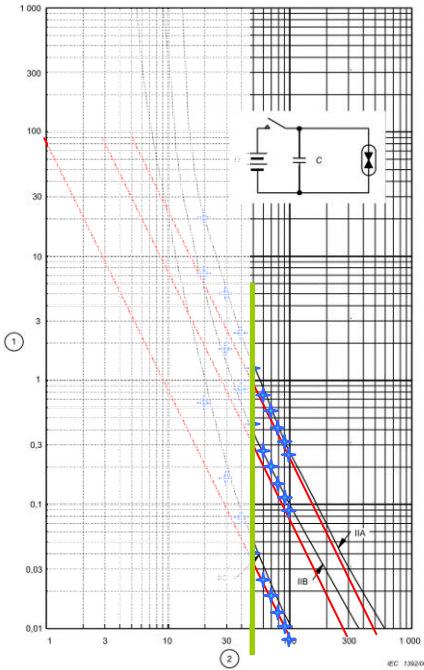

Key
 1 Capacitance C (µF)
 2 Minimum igniting voltage U (V)

Figure A.3 – Group II capacitive circuits

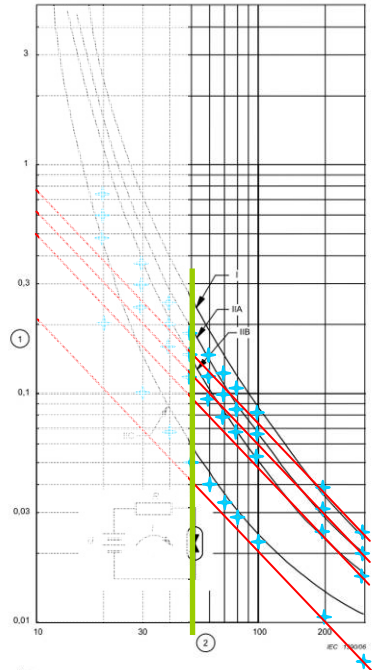

Key
 1 Minimum ignition current I (A) 2 Source voltage U (V)

Figure A.1 – Resistive circuits

The demonstrated approximations refer to a constant energy with capacitive ignition resp. a constant available power with ohmic ones (red lines). Blue symbols do additionally take into account a loss voltage of 10 V and provide an even better matching.

The found individual values of energy resp. power are reported within the table above.

Example

If your source is at $U_0 = 354 \text{ V}$, and targeted gasgroup IIC, you will calculate:

$$R_{\min} = (354 \text{ V} - 10 \text{ V})^2 / ((4 * 0,5 \text{ W}) / 1.5) = 88,8 \text{ k}\Omega$$

$$C_{\max} = 2 * 40 * 10^{-6} / (1.5 * (354 - 10)^2) = 300 \text{ pF}$$

For completion, here is Figure A.2 for capacitive circuits and gasgroup I.

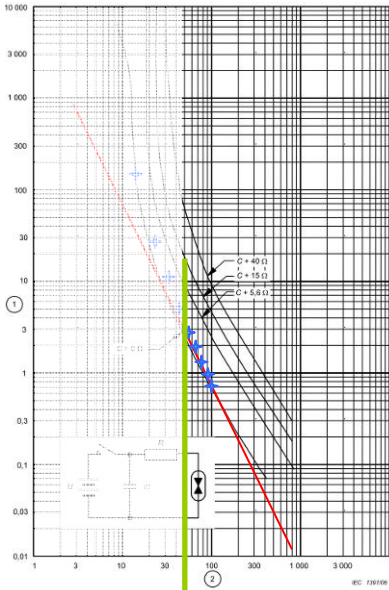

Key
 1 Capacitance C (µF)
 2 Minimum igniting voltage U (V)
 NOTE: The curves correspond to values of current-limiting resistance as indicated.

Figure A.2 – Group I capacitive circuits

Annex L: A statistical approach to spark ignition

Preface:

Other than with Annex H “Statistics of ignition processes”, where some issues are discussed referring to ignition testing up to a certain count of sparks, here some insight shall be gained with respect to the inner properties of such probes of spark testing.

Concept of “spark’s ignition activity” A_F

Although the most obvious property is, whether a single spark ignites or not, it may be of some interest to investigate, how far away from igniting a single spark is situated. Unfortunately, up to now, there is no possibility to observe a single spark this way, and even if one could, additionally a suitable metric has to be found and applied.

Conclusions

There is an ignition activity A_F of single sparks, which is proportional to electrical source’s active electrical data, especially available energy resp. available power which characterizes closeness to real ignition.

An ensemble of single spark’s ignition activity A_F follows a lognormal distribution with a characteristic dispersion factor $\$_{AF}$.

With the standardized spark test apparatus, the dispersion factor $\$_{AF}$ typically is about 1.5.

From a more abstract point of view, this kind, an originally dispersion based effect converts to a punch through one, emanating from source’s electrical activity ($U_o, I_o, C_o \dots$) via ignition activity A_F to ignition probability $W_$.

Initially stored energies nearly play the same quantitative role as spent power. As a result, in an arrangement of a calorical capacitance combined with a calorical shunt resistance (PT_1 structure), a limit temperature can build the scale for ignition activity A_F . And furthermore, it’s possible to define a direct relation between electrical data and ignition probability $W_$ revealing, among others, the effectiveness of a safety factor (1.5).

A procedure “determining minimum ignition energy”

Please let's consider the following figure (Thedens^[1]), referring to capacitive spark ignition and especially its relation between ignition probability W_{-} (vertical axis) and open loop voltage U (horizontal axis):



Bild 2-2: Vergleich der Zündwahrscheinlichkeiten des kapazitiven Kontrollkreises

Naturally, ignition probability will reduce when voltage and therefore available spark energy lessens and this sort of plot widely is used to determine the energy associated with a certain ignition probability, for example standard's $w = 10^{-3}$, by extrapolation.

But those diagrams do comprise something more than a “minimum ignition energy” definition.

Therefore, let's try a somewhat more thorough point of view now.

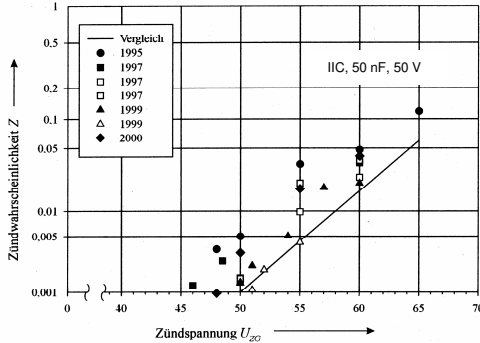
Spark's ignition activity A_F , transition to a stochastic distribution

Although one and the same active electrical source is connected to the standardized spark test apparatus, experiments normally show some sparks producing ignition and others which do not. Therefore there must be some means between the constant electrical source and a constant thermal (calorical) ignition boundary of the gas mixture, which serves for dispersion.

Let's assume, there is an ignition effective magnitude of an actual spark called ignition activity A_F . You may consider it to be somewhat like a thermal energy effectively spent to the gas mixture. Then there is a characteristic boundary value A_{Fzg} associated with the mixture's ignition energy.

In other words: if A_{Fzg} is exceeded by an actual spark's A_F , an ignition occurs, otherwise not. The ignition probability W_- of an ensemble of n sparks is just the portion of sparks exceeding A_{Fzg} with respect to the number n .

An example for ignition activities A_F over a sequence of $n = 100$ observed sparks.

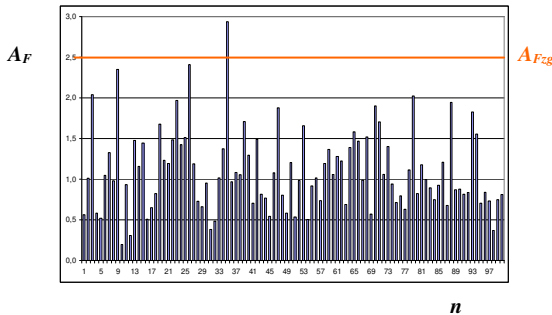

This spark ensemble includes one spark of 100 only, whose A_F exceeds A_{Fzg} , resulting in an ensemble ignition probability W_- of $1 / 100 = 1\% = 0.01$.

For to get some more overview, without altering the interpretation with ignition probability, the order of sparks can be abandoned sorting them by single spark's ignition activity A_F :

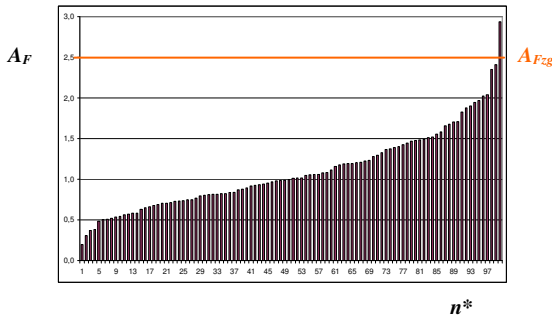

This kind, the "median" $A_{FM} = 1.0$ of the ensemble A_F , which divides the set into a lower and a higher half, can be identified easily.

Making the active electrical source more powerful by a factor 1.1:

Original series:

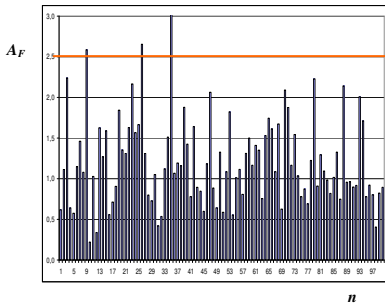

Sorted by magnitude A_F :

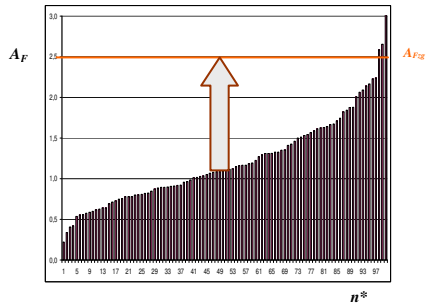

Three sparks within the ensemble will get ignition capable now, resulting in an ensemble ignition probability W_- of $3 / 100 = 3\% = 0.03$.

With capacitive circuits, this action typically can be performed by increasing the voltage by the factor $\sqrt{1.1} \approx 1.05$.

A characteristic situation arises if the electrical source is intensified and A_F increases such that 50% of all sparks do ignite. The arrow in the diagram left directly shows, that the required factor is about 2.3 here.

Note: Between electrical data of the source and spark's ignition activity A_F in principal there is a proportionality factor which will stay hidden as long as the complex chain of electrocalorical effects isn't known in deep detail.

Spark ensemble presentation as cumulative distribution function (cdf)

Above there is given a diagram demonstrating the function A_F over n^* . It's only one step to transform it to a function $W_$ over A_{FM} / A_{Fzg} .

There are several reasons to expect A_F to be distributed in a lognormal way and the intention to demonstrate $W_$ as the portion of igniting to overall sparks suggests to use a graphical representation as lognormal "cumulative distribution function" (cdf) characterized by the parameters median M and dispersion factor $\$_{AF}$.

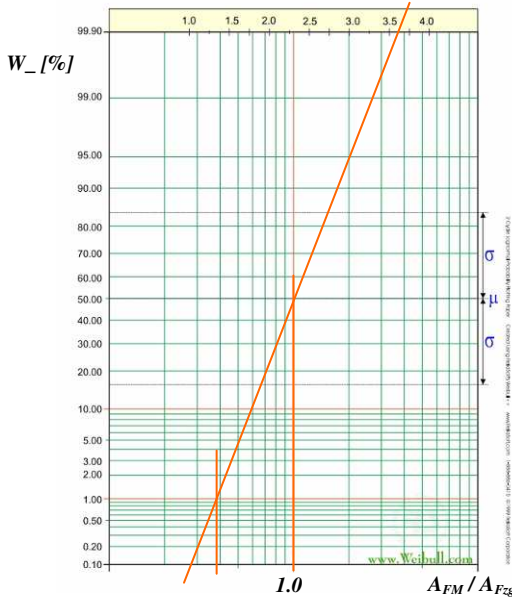

Full description of this special lognormal distribution function are the two parameters median M at $A_{FM} / A_{Fzg} = 1.0$ and dispersion factor $\$_{AF} \approx 1.5$.

If A_{FM} is adjusted, for example by source voltage, to be equal to A_{Fzg} , an ignition probability of 50% results. With the first example above according to an ignition probability of about 1%, A_{FM} / A_{Fzg} is read to be 0.38.

The dispersion factor $\$_{AF}$ in effect acts as a direct but inverse gauge for the slope of the curve.

A border case is reached when dispersion $\$_{AF}$ approaches zero, equivalent to a vertical curve within the cdf diagram. Then the spark ensemble does comprise sparks with one and the same ignition activity A_F only and, dependent on electrical source's activity, all sparks will ignite or all do not. Then only the idea of a precise ignition limit would be adequate.

A cdf diagram adopted for rare incidents

With explosion protection, only very small ignition probabilities are of real concern. Therefore an adjusted cdf diagram has some benefit, concentrating on low W_- and leaving out high ones above 50%: The following diagram complies with median M at $A_{FM} / A_{Fzg} = 1.0$ and dispersion factor $\$_{AF} \approx 1.5$.

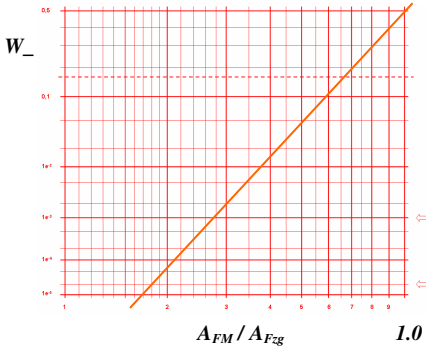

W_-	A_{FM} / A_{Fzg}	A_{Fzg} / A_{FM}	A_{FM} / A_{Fzg} rel. 10^{-3}
0.500	1.00	1.00	3.57
10^{-1}	0.60	1.67	2.13
10^{-2}	0.38	2.63	1.36
10^{-3}	0.28	3.57	1.00
10^{-4}	0.21	4.76	0.75
10^{-5}	0.17	5.88	0.61

With intrinsic safety, whose limits are referred to an ignition probability of $W_- = 10^{-3}$, the last row of the table above surely is the most expressive.

For example, one can detect the efficiency of applying the standardized safety factor 1.5 to spark ignition activity A_F : an ignition probability of $W_- = 10^{-3}$ is mindered this way to somewhat more than $W_- = 10^{-5}$, i.e. somewhat less than two decades.

Furthermore, it can be shown how fluctuations of median ignition activity A_{FM} do feed through to ignition probability W_- . Punchthrough is not constant but dependent on absolute values, nevertheless, in the region $W_- \leq 10^{-3}$ there is a reasonable approximation:

$$\Delta_{W_-} \approx \Delta_{AFM}^{10}$$

Accordingly, a variation in A_{FM} of the factor 1.04, for example, will produce a difference in ignition probability W_- of about the factor 1.48 and viceversa. This may help to understand consequences, for example when ignition probability W_- carries some inherent uncertainty.

How to associate ignition activity A_F with circuit's active electrical data?

Traditionally, inductively or capacitively stored energy is some metric for ignition activity. With no reactances comprised, source's available power may play the same role. Both can be associated with some heating effects.

A severe drawback is the effect, that neither stored energy nor available power are transferred without any loss to the gas mixture. Nevertheless, besides spark's loss voltage which always has to be taken into account, a relatively stable proportionality between either energy or power is found according to the type of electrical circuit.

Let's return to Thedens' report of capacitive ignition, measured in diverse years:



Bild 2-2: Vergleich der Zündwahrscheinlichkeiten des kapazitiven Kontrollkreises

Obviously the interpolation lines have nearly the same slope, indicating comparable dispersions $\$U$, apart from some small differences in position.

Transferring the green dashed line as a mean into the diagram for rare incidents:

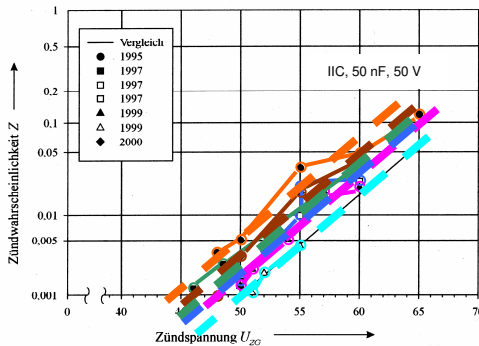
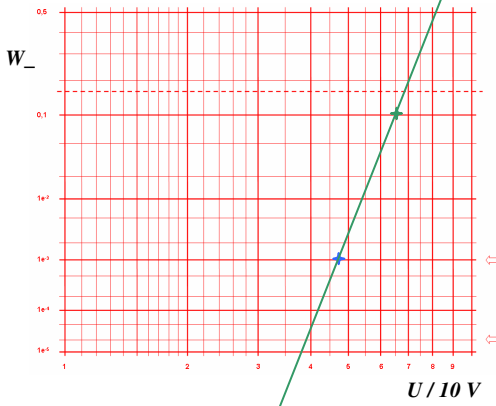

The characteristic (U) values at $W_ = 0.5$ and $W_ \approx 0.16$ directly give the dispersion factor $\$U$ with a lognormal distribution, here the dispersion factor $\$U = 81 / 69 = 1.17$ arises.

But if reference to an ignition effective energy is to be strived for, a loss voltage of about 10 V has to be taken into account and voltage has to be transformed to energy. Therefore the A_F related dispersion factor must be calculated to $\$A_F = [(81-10)/(69-10)]^2 = 1,45$.

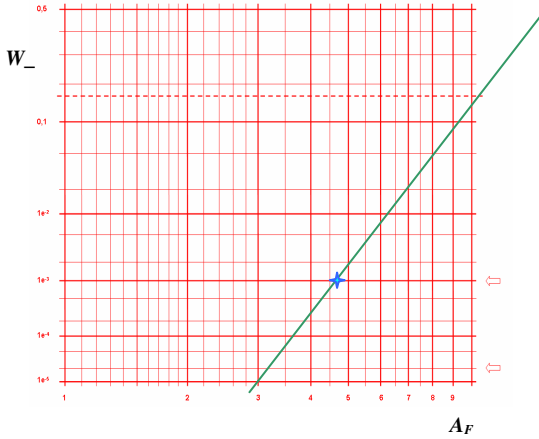

Note: The position of the curve intentionally is adjusted to be equal to the original U related one at $W_- = 10^{-3}$.

Great thanks to Mr. Cawley

There are very little publicly available information about the punch-through of spark ignition activity A_F to ignition probability W_- , especially with very low ignition probabilities. Here is the most impressive one reported by Cawley^[2]:

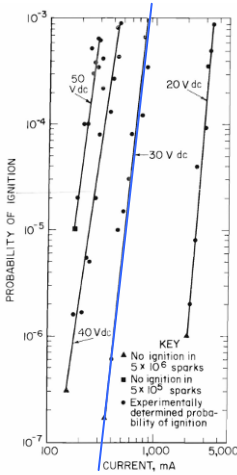

FIGURE 7--Probability of spark ignition for resistor test circuits versus current in 8.3% methane-air atmospheres.

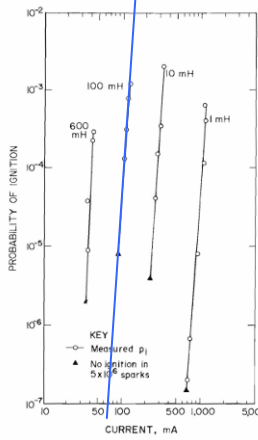

FIGURE 10--Probability of spark ignition for inductor test circuits versus current in 8.3% methane-air atmospheres.

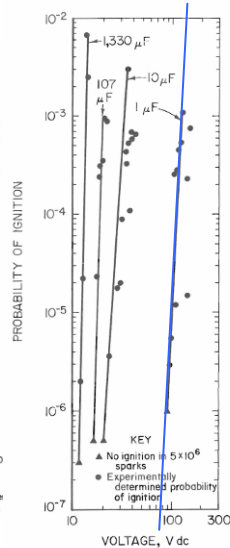
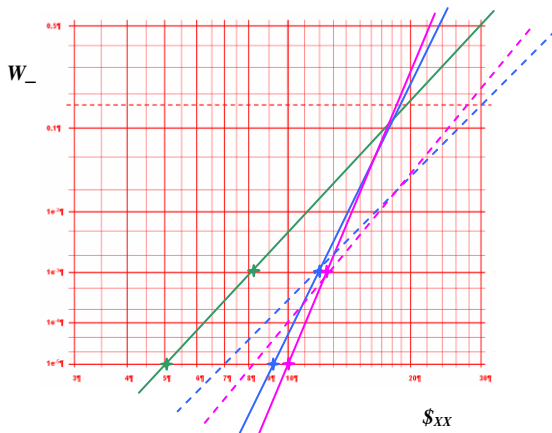

FIGURE 13--Probability of spark ignition for capacitor test circuits versus voltage in 8.3% methane-air atmospheres.

Transferred to the diagram for rare incidents ($W_- = 10^{-3}$ resp. $W_- = 10^{-5}$):



Solid lines, originally from Cawley: green: ohmic, blue: inductive, pink: capacitive.

Dashed lines: inductive and capacitive, corrected by drawing the root of $_{XX}$ to get $_{AF}$.

Please see, all $_{AF}$ are nearly of the same magnitude from 1.44 to 1.59 here. It seems $_{AF} = 1.5$ to be a significant value for the dispersion, an electrically spent energy resp. power experiences on the way to possible ignition with the standardized spark test apparatus.

The root of initially stored energies (cap. / ind.) in principal plays the same quantitative role as spent power (ohmic).

As a result, in an arrangement of a caloric capacitance combined with a caloric shunt resistance (PT_1 structure), a limit temperature can build the scale for ignition activity A_F .

Note: When treated as above, with high voltage capacitive ignition data, a typical dispersion factor $_{AF} \approx 1.25$ is found instead of 1.5 (which is characteristic for the standardized spark test apparatus). Facing, that the former uses fixed contacts but the latter moving ones introducing further variations, the difference between the dispersion factors is surprisingly small.

Cited:

- [1] Martin Thedens, „Funkenzündung von Gasgemischen bei erhöhten Drücken und Temperaturen für die Zündschutzart Eigensicherheit“, PTB-Bericht PTB-ThEx-23 (2002)
- [2] James C. Cawley, "Probability of Spark Ignition in Intrinsically Safe Circuits", Bureau of Mines Report of Investigations/1988, RI 9183

Annex M: Checking presented ignition Data

Preliminary

Sometimes there are doubts with presented ignition data and experiments using the standardized spark test apparatus (STA) are carried out to confirm or refuse them. Here some related issues are discussed.

Conclusion

In principal, standard's philosophy seems to pick up the idea of a strict ignition boundary and assumes the application of the safety factor 1.5 to be sufficient to reduce ignition probability to zero, even covering eventual imprecision with its own data acquisition and representation.

Any attempt of validation using the standardized spark test apparatus and analysis in a naive way will reveal very surprising results. An advanced knowledge however will disclose the idea of an absolute ignition limit to be a simplification.

Achieving even at least some coherence is nontrivial.

With pure safety aspects however, the idea may work satisfactorily often.

Note: In certain cases, committee permits a 10% reduced safety factor.

An example circuit 50 nF

With gasgroup IIC according to *IEC_{kap}* Figure A.3 an open loop voltage of 50 V results in a permissible capacitance of 50 nF.

This is in perfect conformity with experiments carried out in PTB in 1999 with ignition probability 10^{-3} (Bild 2-2).

But Bild 2-2 includes experiments of PTB also, conducted in different years:



Bild 2-2: Vergleich der Zündwahrscheinlichkeiten des kapazitiven Kontrollkreises



Key
1 Capacitance C (µF)
2 Minimum igniting voltage U (V)

Figure A.3 – Group II capacitive circuits

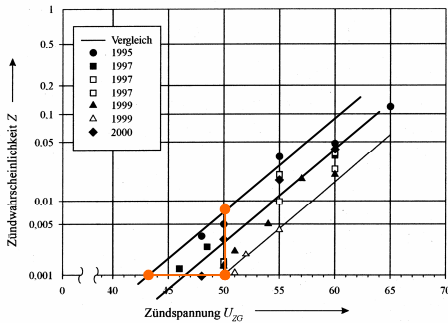
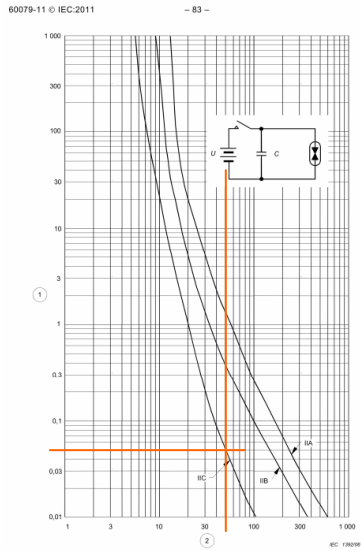
Although PTB struggled to keep experimental conditions exactly the same, some differences arose. In voltage there is a maximum relation (1995 re. 1999) of $43 \text{ V} / 50 \text{ V} = 0,86$.

Note: With different test stations, the deviation should be significantly larger.

Checking the example circuit 50 nF

Imagine, a circuit with an open loop voltage of 33,3 V and a capacitance of 50 nF has to be experimentally tested by using the standardized spark test apparatus. Applying the required safety factor 1.5 the open loop voltage is adjusted to 50 V.

Starting the standardized test run over 400 revolutions (1600 contacts), the tester expects no ignition as the circuit obviously complies with Figure A.3.

According to the known exponential distribution of revolution counts between ignitions however, the chance to stand this test is about 20% only (see chapter H). However, in most cases the test fails and the tester will feel doubts with the reported limit data..

Maybe he isn't discouraged at all and repeats the test again and again arithmetically cumulating the counts between ignitions. In the end it's turned out, that the arithmetic mean tends to a stable value. With setup "PTB 1999" this will be near to 1000 which is the standard's intended base.

But, if accidentally the test setup resembles "PTB 1995", the resulting arithmetic mean will about 140 only, which is far away from the expected value.

How to rate this issue?

IEC_{kap} Limit curves and ignition probability

Picking up Bild 2-2 once more, it's possible to complete Figure A.3 of IEC_{kap} by additional curves representing the situation with ignition probabilities other than 10⁻³ (fat orange). This is done here with the ignition probabilities 10⁻², 10⁻⁴ and 10⁻⁵ (lean orange) based on "PTB 1999".

Most essential insight is recognizing the fact, that there is no sharp limit but a continuum of ignition probability with a spent electrical activity.

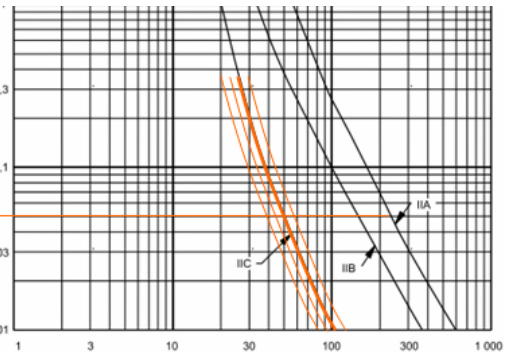

This can be an ideal opportunity to introduce a further curve representing the application of the standardized safety factor 1.5 in voltage (light blue).

Obviously safety factor application will reduce ignition probability very efficiently. In this case one can estimate a value of about 10⁻⁶.

The punch-through of electrical activity to ignition probability isn't absolute but obviously very strong.

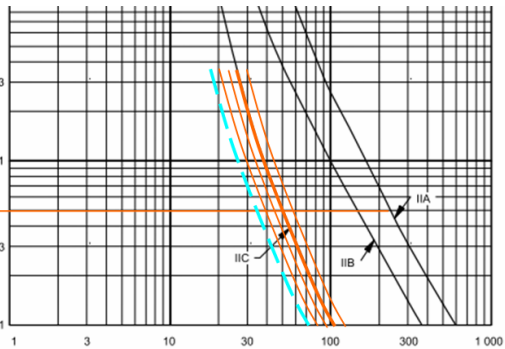

It seems, standard's philosophy adheres to the idea of a strict ignition boundary and grants a more or less precise detection of it by experiments. If so, the number of the safety factor requires no special value but has to be large enough only. The factor 1.5 is stated by the standard to be sufficient.

Checking the example circuit 50 nF (continued)

The test operator, experiencing the unsatisfactory test result of a "PTB 1995" environment, may be aware of the applied safety factor and has the idea to try out to which amount it has to be lessened to reach the allowed ignition probability 10⁻³.

He will find out, according to Bild 2-2, that the circuit 50 nF with a reduced test voltage of 43 V (instead of 50 V) will stand the ignition probability requirement 10⁻³.

May this finding consolidate the situation?

The “testsafe problem 2018”

A problem of this kind was raised by testsafe in 2018. In this case an observation was reported, that a capacitive circuit dimensioned according to the standard “will ignite” if the current limiting resistor is lowered to the minimum allowed with a pure ohmic situation (that’s some kind of a “mixed circuit”).

In progress, PTB presents experimental results, revealing that a reduction of about 10% in voltage will correct the ignition probability to the required value 10^{-3} .

Committee thereupon decided a 10% reduced safety factor to be acceptable.

A rudimentary approach to a basic problem analysis

A standard is intended to set strong limits, there should be no room for interpretations.

On the other hand side, often they have to manage a stress between reasonable accuracy and sufficient applicability of data, while knowledge and room in standard's volume are restricted. This is performed often by introduction of safety factors whose load capacity sometimes maybe in question.

An inherent stress with intrinsic safety lies in the relation of experimental tests using the spark test apparatus and reference data. This is because the expressiveness of spark tests initially is restricted to a binary result, gaining a quantitative character usable for limit values not before being carried out a lot of times and are interpreted carefully.

Dispersion transfer from Bild 2-2 to IEC_{kap} Figure A.3

As an illustration for typical uncertainties with spark ignition measurements please see here an excerpt of IEC_{kap} Figure A.3 showing a limit curve broadened to comprise all single PTB experiments “1995” ... “2000”.

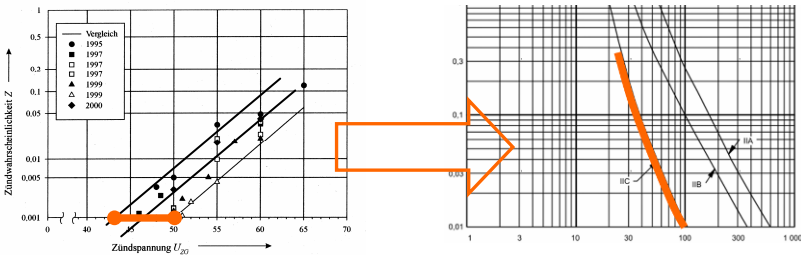

Bild 2-2: Vergleich der Zündwahrscheinlichkeiten des kapazitiven Kontrollkreises

Obviously a really precise metering is not possible.

Cited:

[1] Martin Thedens, „Funkenzündung von Gasgemischen bei erhöhten Drücken und Temperaturen für die Zündschutzart Eigensicherheit“, PTB-Bericht PTB-ThEx-23 (2002)